

PRODUCT SPECIFICATION

Model No.: FYS-5017A/BX-XX

Descriptions & Features:
<ul style="list-style-type: none"> ■ 0.50 Inch (12.70mm) digit height Single Digit Display ■ Case mold type. ■ RoHS compliant. ■ Low current operation ■ Low power consumption. ■ Easy mounting on P.C. board or socket.



CUSTOMER APPROVED SIGNATURES	APPROVED BY	CHECKED BY	PREPARED BY

NINGBO FORYARD OPTOELECTRONICS CO.,LTD

Add:NO.115 Qixin Road Ningbo Zhejiang China

Zip:315051

Tel: 0086-574-87933652 87927870 87922206

Fax: 0086-574-87927917

E-mail:Sales@foryard.com (General)

[Http://www.foryard.com](http://www.foryard.com)

Model No.: FYS-5017A/BX-XX

■ -XX: REF Surface / Epoxy color

Color \ Number	0	1	2	3	4
REF Surface Color	<input type="radio"/> White	<input type="radio"/> Black	<input type="radio"/> Gray	<input type="radio"/> Red	<input type="radio"/> Green
Epoxy Color	<input type="radio"/> Water Clear	<input type="radio"/> White	<input type="radio"/> Red	<input type="radio"/> Green	<input type="radio"/> Yellow

■ Mechanical Dimensions

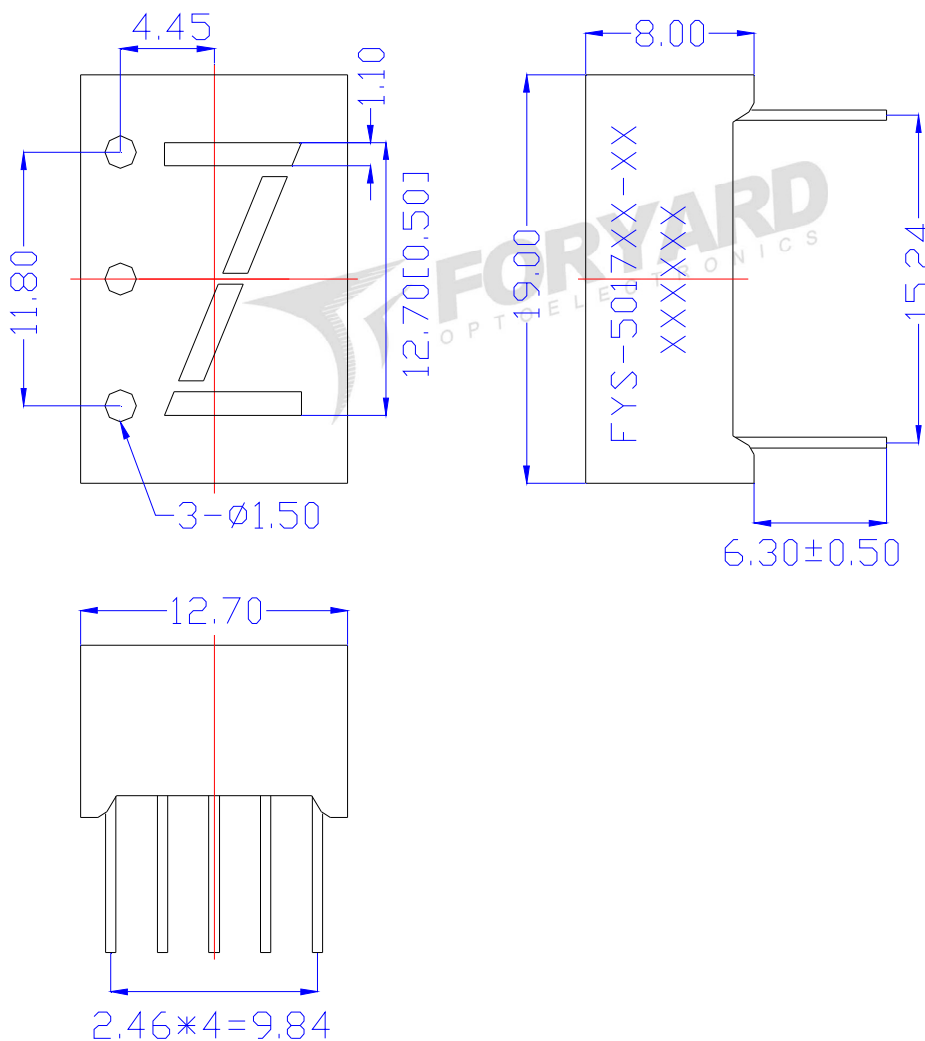

Notes:

1. All pins are $\Phi 0.51 [0.020]$ mm
2. Dimension in millimeter [inch], tolerance is $\pm 0.25 [0.010]$ and angle is $\pm 1^\circ$ unless otherwise noted.
3. Bending \leq Length * 1%.
4. The specifications, characteristics and technical data described in the datasheet are subject to change without prior notice.

Model No.: FYS-5017A/BX-XX

■ All Light On Segments Feature & Pin Position

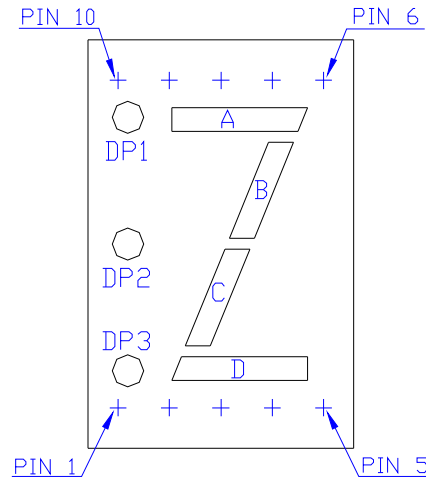

■ Internal Circuit Diagrams

FYS-5017AX

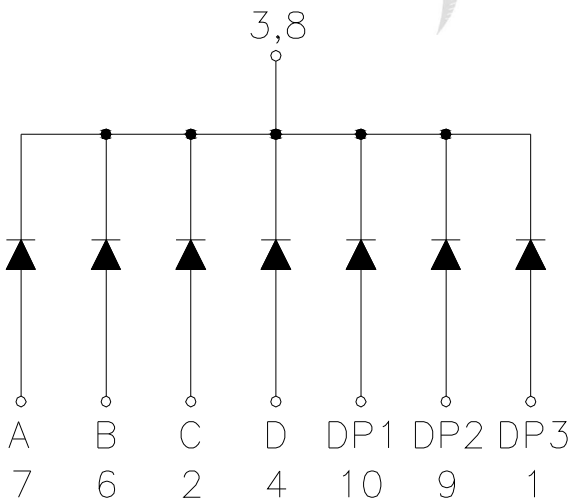

No.: 5 NO Connect
Common Cathode

FYS-5017BX

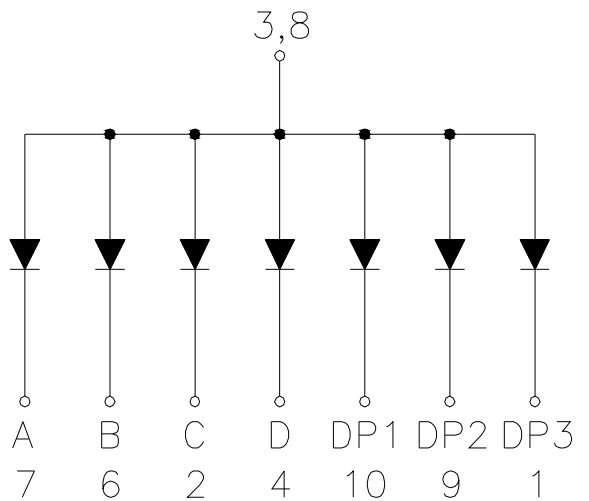

No.: 5 NO Connect
Common Anode

Model No.: FYS-5017A/BX-XX

■ Absolute maximum ratings

(Ta=25°C)

Parameter	Symbol	Test Condition	Value		Unit
			Min	Max	
Reverse Voltage	VR	IR=30	5	—	V
Forward Current	IF	—	—	30	mA
Power Dissipation	Pd	—	—	100	mW
Pulse Current	Ipeak	Duty=0.1mS,1KHz	—	150	mA
Operating Temperature	Topr	—	-40	+85	°C
Storage Temperature	Tstr	—	-40	+85	°C

■ Electrical-Optical Characteristics

● Color Code & Chip Characteristics:(Test Condition:IF=20mA)

(Ta=25°C)

Emitting Color	Dice Material	Peak Wave Length(λ_p)	Spectral Line halfwidth($\Delta\lambda_{1/2}$)	Forward Voltage(VF) Unit:V		Luminous Intensity (Iv) Unit:mcd	
				Typ	Max		
Standard brightness							
H	Red	GaP	700nm	90nm	2.00	2.50	1
S	Hi Red	AlGaAs/SH	660nm	20nm	1.80	2.50	15~20
D	Super Red	AlGaAs/DH	650nm	20nm	1.90	2.50	26~38
E	Orange	GaAsP	625nm	35nm	1.90	2.50	14~20
A	Amber	GaAsP	610nm	35nm	1.90	2.50	13~18
Y	Yellow	GaAsP	590nm	35nm	1.90	2.50	13~18
G	Green	GaP	570nm	10nm	1.90	2.50	14~18
B	Blue	InGaN	430nm	60nm	3.40	4.40	0.7~1(mw)
			460nm		2.80	3.80	6~12(mw)
			470nm		2.80	3.80	6~12(mw)
PG	Pure Green	InGaN	520nm	36nm	2.80	3.80	4~6(mw)
W	White	InGaN	X=0.29,Y=0.30	CCT:9500K	2.80	3.80	20~30
Ultra brightness							
UHR	Ultra Hi Red	AlGaInP	640nm	20nm	1.90	2.50	30~60
UR	Ultra Red	AlGaInP	635nm	20nm	1.90	2.50	60~100
UE	Ultra Orange	AlGaInP	625nm	20nm	1.90	2.50	60~120
UA	Ultra Amber	AlGaInP	610nm	20nm	1.90	2.50	40~100~150
UY	Ultra Yellow	AlGaInP	590nm	20nm	1.90	2.50	50~140~190
UG	Ultra Green	AlGaInP	570nm	30nm	1.90	2.50	30~60~80
PG	Ultra Pure Green	InGaN	520nm	36nm	2.80	3.80	260~310
BG	Ultra Bluish Green	InGaN	505nm	36nm	2.80	3.80	260~310
UB	Ultra Blue	InGaN	460nm	30nm	2.80	3.80	80~90~120
			470nm	30nm	2.80	3.80	80~90~120
UW	Ultra White	InGaN	X=0.29,Y=0.30	CCT:9500K	2.80	3.80	180~200
Segment-to-Segment Luminous Intensity ratio(Iv-M)				1.5:1			

Note:

- 1.Luminous Intensity is based on the Foryard standards.
- 2.Pay attention about static for InGaN

Model No.: FYS-5017A/BX-XX

■ Packing Diagram

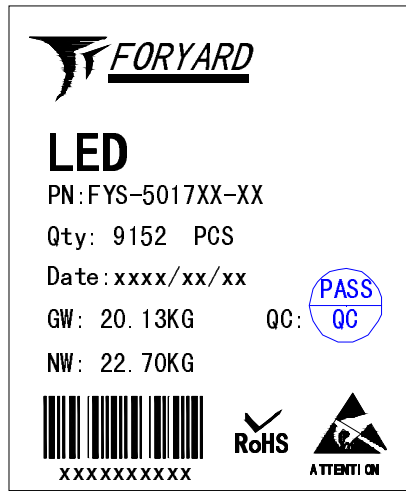
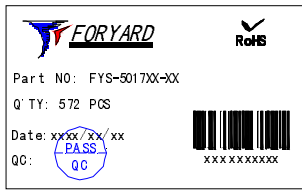
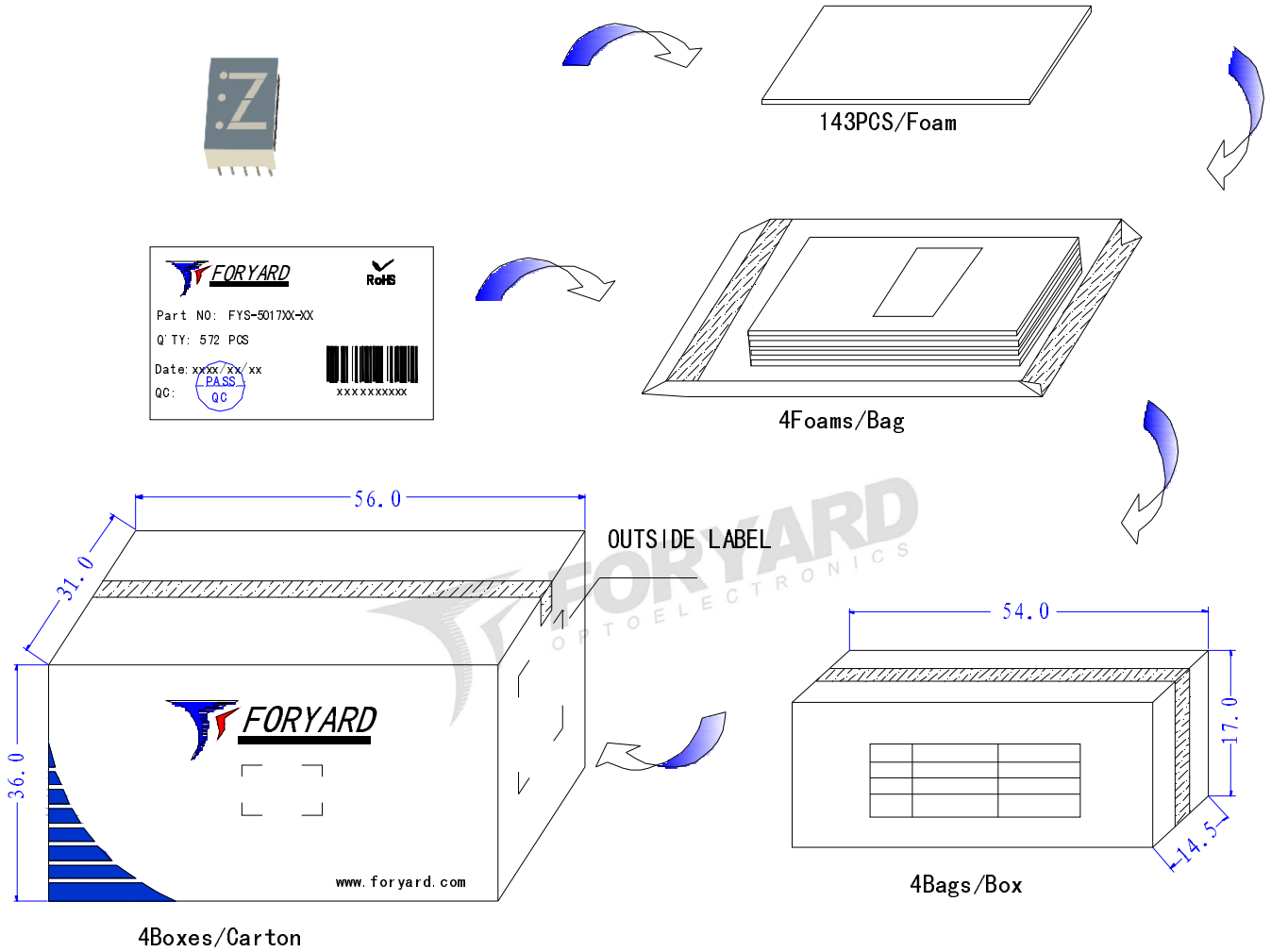

OUTSIDE LABEL

Note: The specifications are subject to change without notice. Please contact us for updated information.