

## Technical Specifications

# **nano XED**

## 6500K DAYLIGHT WHITE

Part number: LX-01NXX-65W-00-00 \*)

  
**6500K**  
Daylight white



\*) Note:  
Description of  
part number  
refer to page 14.

Rev.03 (04/07)



## UNIQUE FEATURES

- Proprietary Chip-in-Silicon [CiS] technology
- Silicon (Si-wafer) generic package
- Miniature form factor: 2.5mm x 2.5mm x 0.6mm
- Toyoda Gosei Blue InGaN core emitter
- Single chromatic range with tight tolerance: Mac Adams 6
- Best-in-class Thermal Resistance: 12K/W
- Suitable for assembly on standard FR4 PCB

## DESIGNED & SPECIFIED FOR

- Automotive interior lighting
- Automotive daytime running lights
- Medical & dental lighting
- Transportation equipment interior lighting (aircraft, train, vessels)
- Emergency luminaries
- Flash for hand-held electronic devices (mobile phones, PDAs)
- Backlight light source for LCD displays
- Substitution of halogen lamps
- Decorative and architectural lighting
- Accent lighting
- High quality torch & recreational lamps
- Industrial equipment lighting

. CCT: 6500K

. Luminous Flux: 35 Lumen

. Standard SMT assembly

. Typical Average Lifetime\*):  
> 50,000 hours

. ESD-withstand voltage: 2kV

. Efficacy: 50 lm/W

\*)Note:  
Conditions at  
 $T_a=25\text{ }^\circ\text{C}$ ,  
 $T_s=45\text{ }^\circ\text{C}$ ,  
 $I_f=200\text{mA}$



### Absolute Maximum Ratings

Ta=25°C

Parameter	Symbol	Value	Unit
Power Dissipation	$P_D$	0.95	W
DC Forward Current	$I_F$	250	mA
Pulsed Forward Current (10ms pulse width of duty 10%)	$I_{FP}$	600	mA
Reverse Voltage	$V_R$	5	V
Operating Temperature	$T_{op}$	-40 ~ +115*)	°C
Storage Temperature	$T_{stg}$	-40 ~ +115	°C
Junction Temperature	$T_j$	140	°C

Allowable Forward Current vs Ambient Temperature

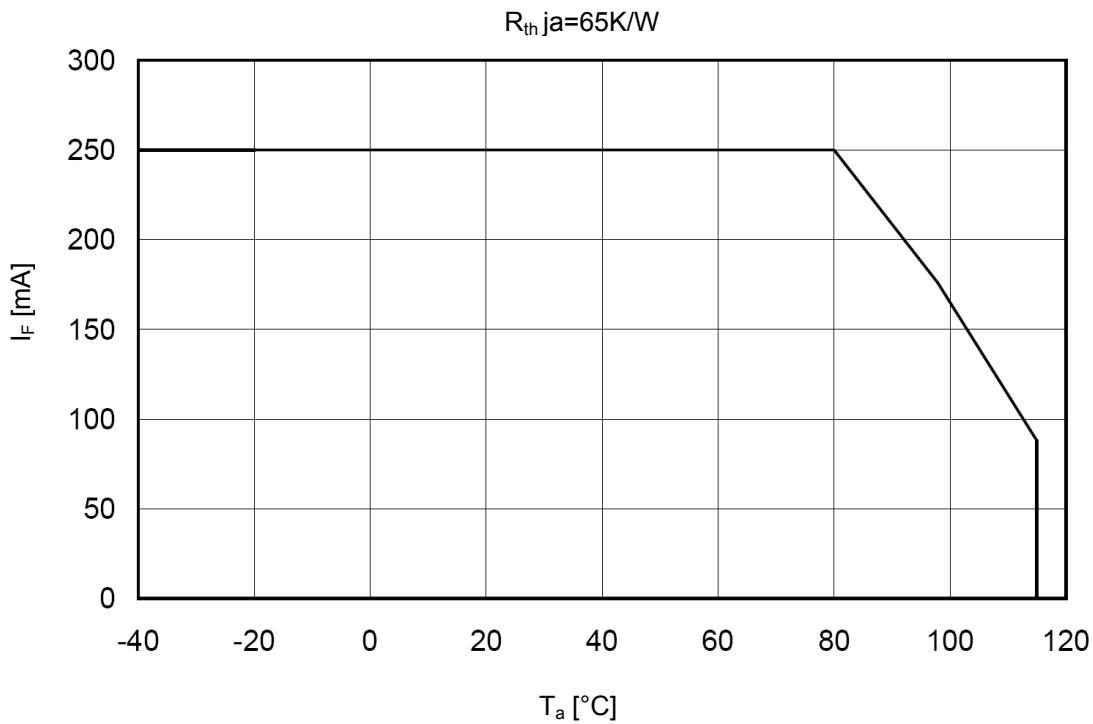

\*)Note:  
 $T_{max}$  -  
 conditions at  
 $I_F=150mA$ ,  
 $R_{thja}=35K/W$



## Electro-Optical Characteristics

$T_a=25^{\circ}\text{C}$ ,  $T_J=30^{\circ}\text{C}$

Parameter	Symbol	Condition	typ	max	Unit
Forward Voltage	$V_F$	$I_F=200\text{ mA}$	3.2	3.8	V
DC Forward Current	$I_F$		200	250	mA
Viewing Angle	$2\theta_{1/2}$	$I_F=200\text{ mA}$	120	-	deg
Colour Temperature	$CT$	daylight white	6500		K
Chromaticity Coordinate	$X$	$I_F=200\text{ mA}$	0.313		
	$Y$	$I_F=200\text{ mA}$	0.327		
Luminous Flux	$\phi_V$	$I_F=200\text{ mA}$	30		lm

Ranking  $I_F=200\text{ mA}$ ,  $T_a=25^{\circ}\text{C}$ ,  $T_J=30^{\circ}\text{C}$

Rank	Luminous Flux $\phi_V$ [lm]	
	Min.	Max.
A	19	23
B	23	27
C	27	31
D	31	35

Ranking  $I_F=200\text{ mA}$ ,  $T_a=25^{\circ}\text{C}$ ,  $T_J=30^{\circ}\text{C}$

Rank	Luminous Intensity $I_V^*$ [cd]	
	Min.	Max.
A	7	8.4
B	8.4	9.9
C	9.9	11.4
D	11.4	12.8

\*) Note:  
 XEDs have a 100% final testing procedure in the production.  
 The measurement includes the luminous intensity (cd) and chromaticity coordinates.  
 Tolerance ranges:  
 $I_V - \pm 10\%$   
 $CIE - \pm 0,01$   
 These measured values are basis for the release of the delivery.



### Chromaticity Coordinates Diagram

CIE Coordinates: Tolerance area  
**MacAdams 6\*)**  
White 6500 K  
Target Coordinates:  
 $x=0,313$   $y=0,327$   
at  $I_F=200$  mA,  $T_a=25^\circ\text{C}$ ,  $T_J=30^\circ\text{C}$

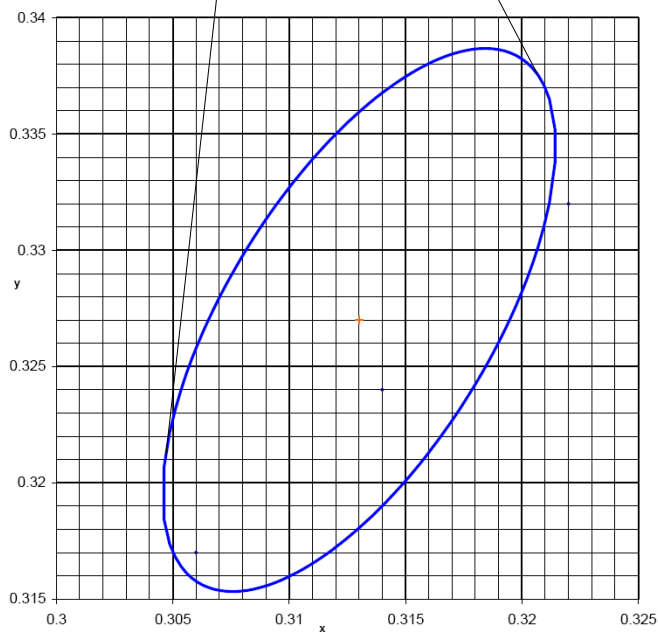
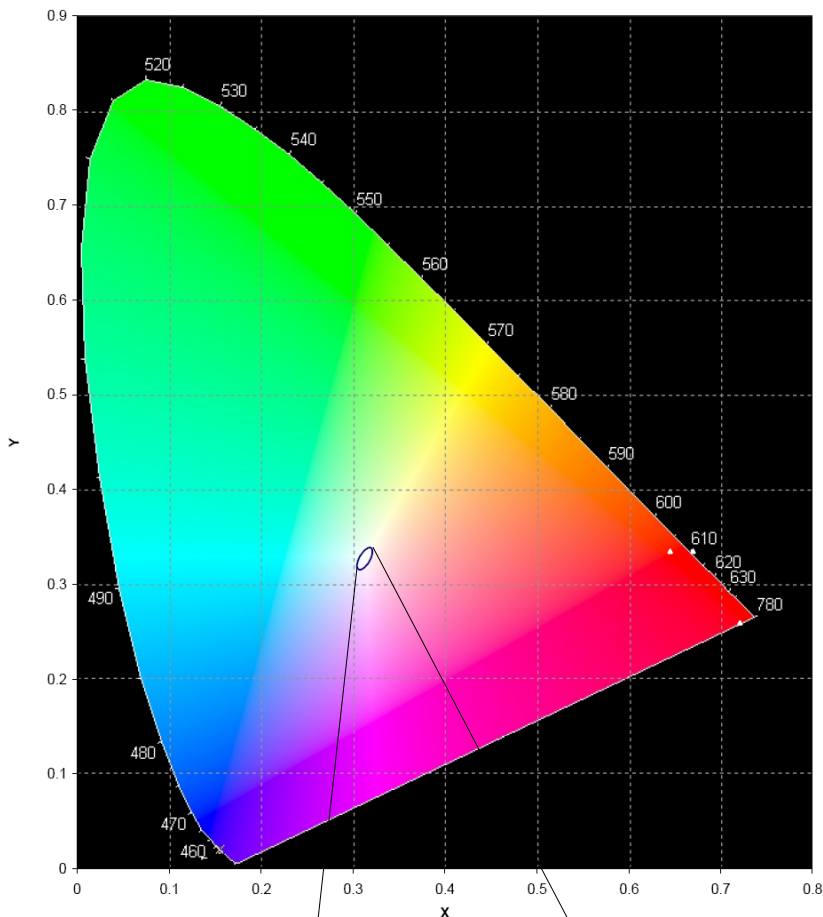

\*) Note:  
The CIE-area inside the MacAdams Ellipse 6 (acc. to IEC 60081) appears as an equal color so that the chromaticity differences between the center of the ellipse and any point on the ellipse can hardly be perceived .  
Measurement tolerance:  $\pm 0,01$



### Reference Curves (typical values)

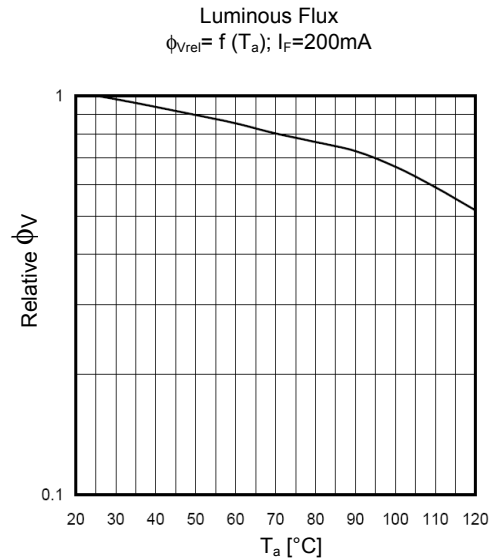
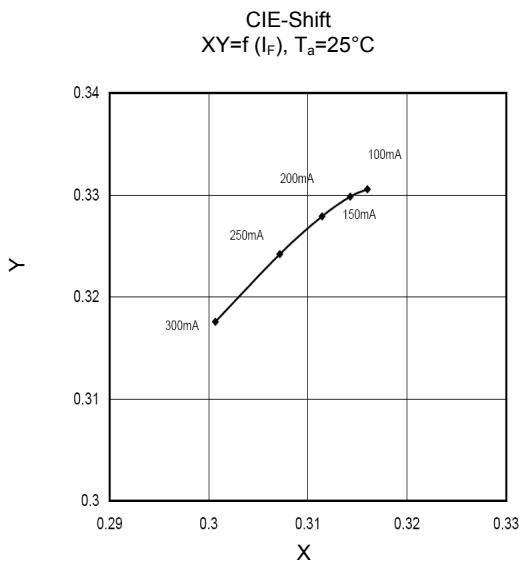
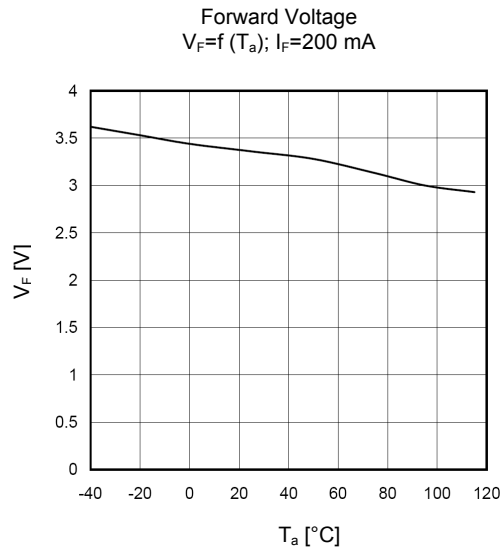
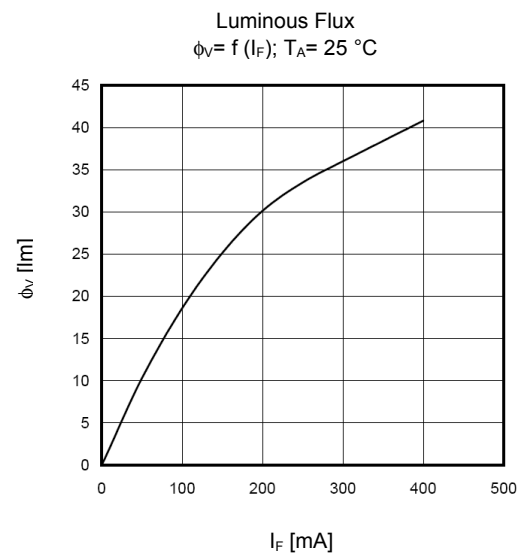
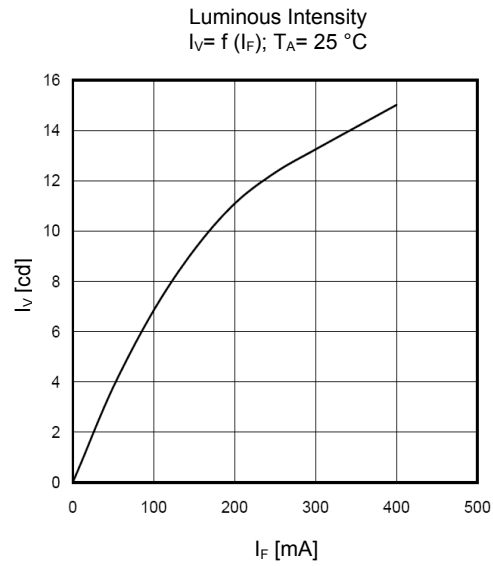
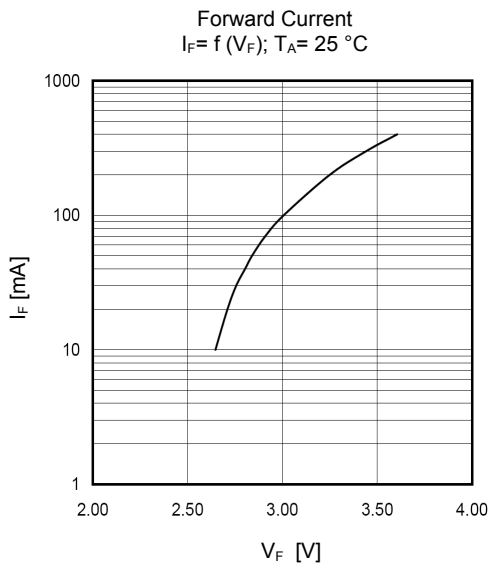



Relative Spectral Emission  
 $I_{v-rel} = f(\lambda); I_F=200\text{mA}, T_a=25^\circ\text{C}, T_J=30^\circ\text{C}$

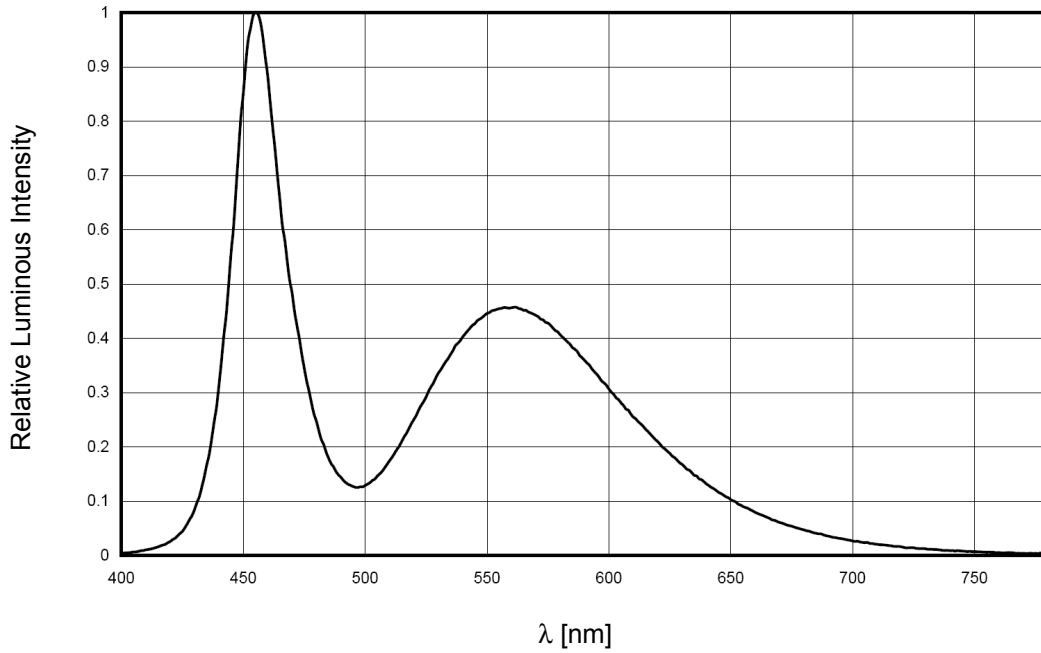

Radiation Characteristic  
 $T_a=25^\circ\text{C}$

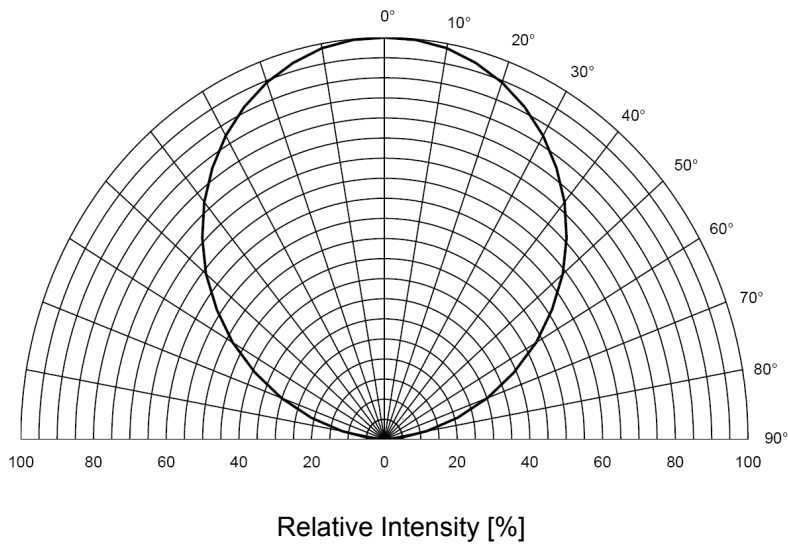



## Soldering Guidelines

- Soldering paste and optical layer must not come into contact. This could affect the performance of the component.
- Do not exert external pressure on any part of the resin when soldering.
- The component should be cooled to room temperature before further processing.
- This product is not suitable for wave soldering. Use re-flow solder or use a hot plate when soldering.
- Soldering under N<sub>2</sub>-atmosphere is recommended to maintain reliability.
- Soldering rework is not recommended.
- Do not implement multiple re-flow methods.
- After soldering, do not bend the circuit board.

## Solder Pad / Footprint

(Unit:mm)

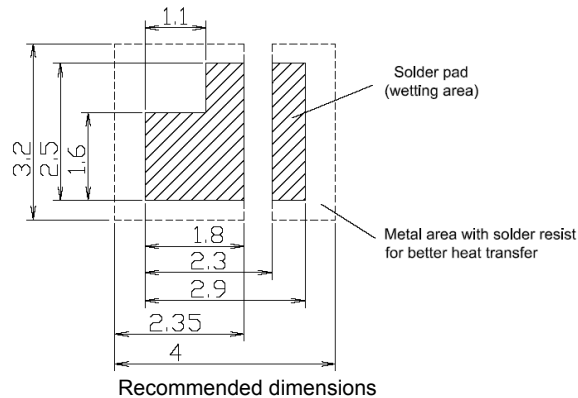

Note: The solder pad should be close to the electrode area, as recommended.  
The larger the metal area with solder resist, the better the heat transfer.

## Reflow Soldering Conditions / Profile

- Preheat to be at maximum 200°C for maximum 2 minutes.
- Soldering temperature should not exceed 260°C for maximum 10 seconds.

Recommended soldering conditions (surface of circuit board) –lead-free solder

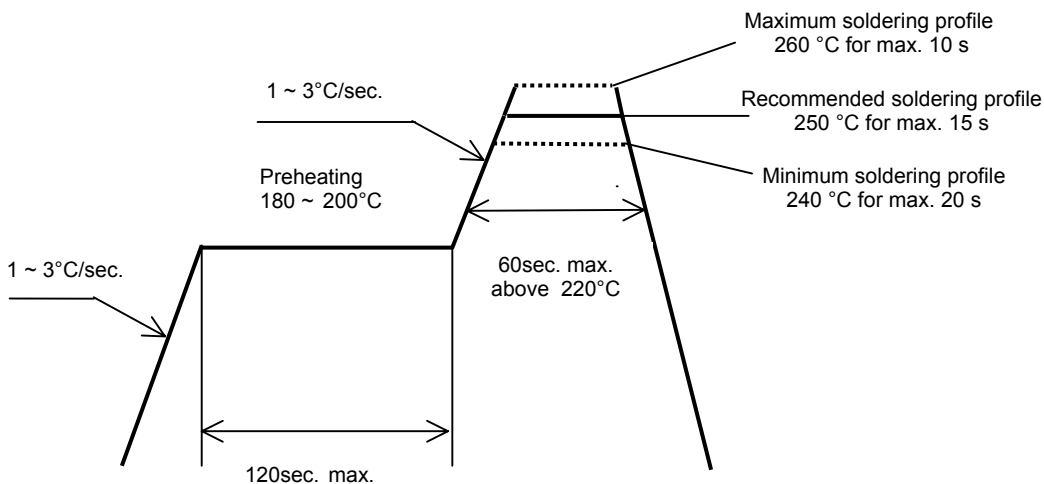





- Please check the mounting reliability based on the application.
- Excessive coating of solder paste on the board may result in the formation of a “Solder Ball” on the board and/ or on the side surface of the XED after reflow. Customer should take note that the “Solder Ball” may cause a short circuit.
- A too large solder pad area can cause the XED to move out of place. Therefore it is our recommendation that only our recommended footprint with an adapted solder paste quantity should be used.

## Thermal Management

- Thermal design of the end product is critical to the performance of the XED. The heat generation of the XED must be considered when making the system design.
- Operate XEDs within the maximum ratings given in this specification.
- Please choose only an operating current according to XED’s ambient temperature given in this specification and connect the XED to a suitable cooling system.
- The equation below indicates correlation between  $T_J$  and  $T_A$ .

$$T_J = T_A + R_{thJA} * P$$

Definitions and Abbreviations:

- $T_J$  = Junction Temperature: [°C]
- $T_A$  = Ambient Temperature: [°C]
- $R_{JA}$  = Thermal resistance from XED Junction to Ambient: [K/W]
- $P$  = Power Input ( $I_F * V_F$ ): [W]

### Typical Thermal Resistance Junction-Solder Point:

$$R_{thJS} \text{ typ.} = 12 \text{ K/W}$$

### Schematic diagram of thermal package

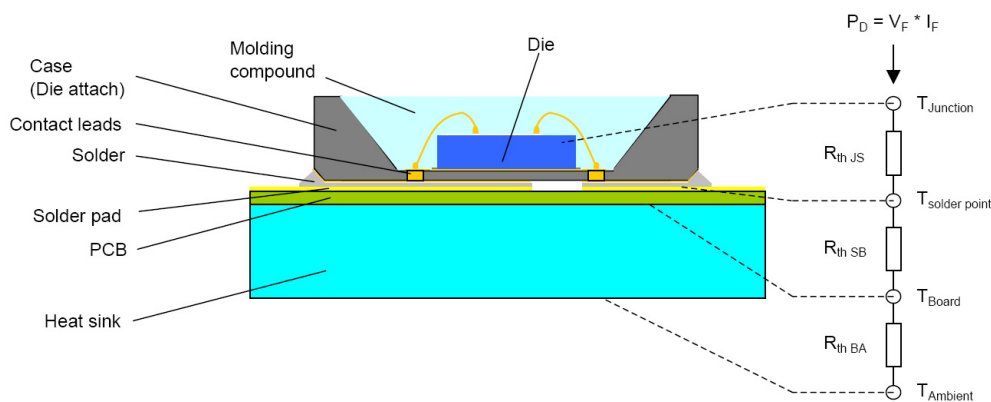



## General Guidelines

- The XEDs described in this brochure are intended for ordinary electronic equipment such as office equipment, communications equipment, measurement instruments and household appliances. Consult LEXEDIS sales staff in advance for information on the applications in which exceptional quality and reliability are required, particularly when the failure or malfunction of the XEDs may directly harm life or health (such as for airplanes, aerospace, submersible repeaters, nuclear reactor control systems, automobiles, traffic control equipment, life support systems and safety devices).
- User shall not reverse engineer by disassembling or analysis of the XEDs without having prior written consent from LEXEDIS. In the rare occurrence that XEDs are found faulty, the user shall inform LEXEDIS directly before disassembling or analysis.
- The formal specifications must be agreed and signed by both parties prior to large volume purchase begins.
- The appearance and specifications of the product may be modified for improvement without prior notice.



### Outline Dimensions

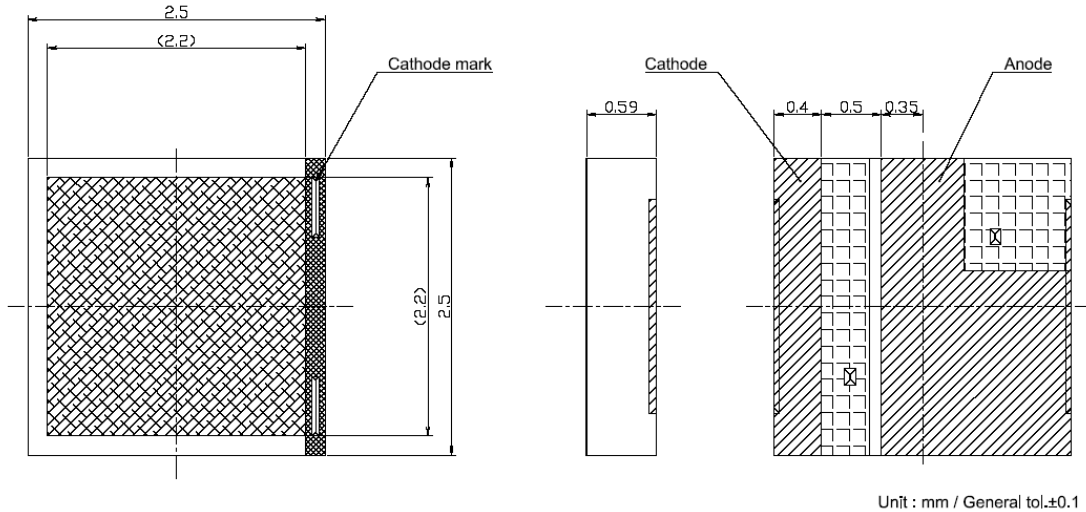

Item	Material
Package	Silicon
Encapsulating	Silicone and Phosphor

### Packing

- Quantity is 2000 pcs/reel.
- The reel is packed in an antistatic plastic pack.
- The XEDs are packaged in cardboard boxes for transportation.
- The packages should be handled carefully to avoid damage of the components.
- The boxes are not waterproof and therefore must be protected from water and moisture.
- When the XEDs are transported, we recommend using the same packing method as LEXEDIS.



### Reel Packing Structure (Reel $\phi$ 180mm)

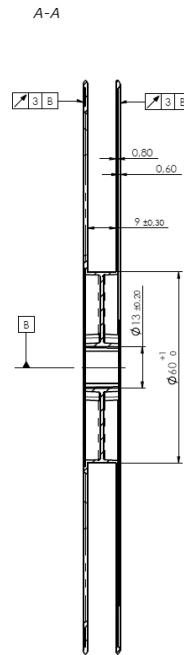
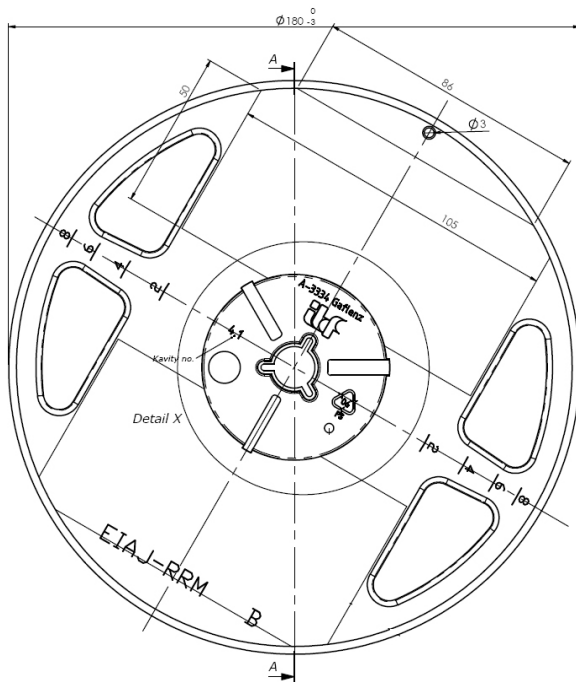
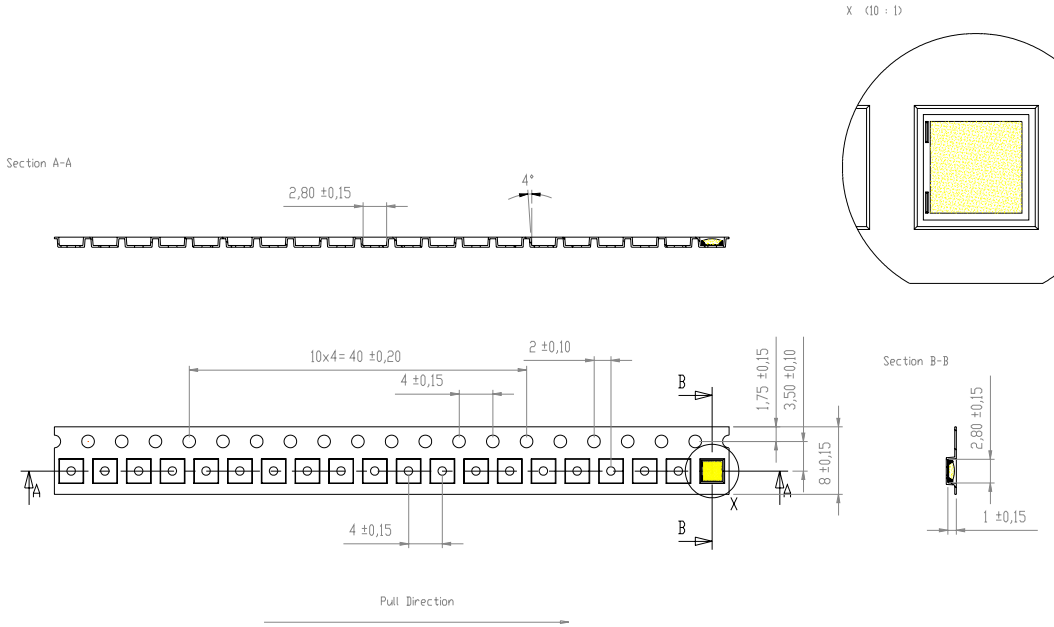



## Labeling

The label on the packing units shows the part number, quantity, date and lot number.

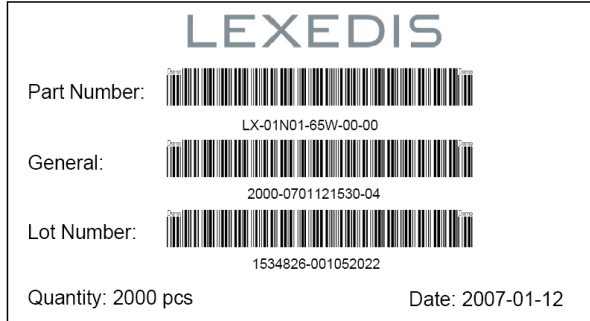

## Label positions

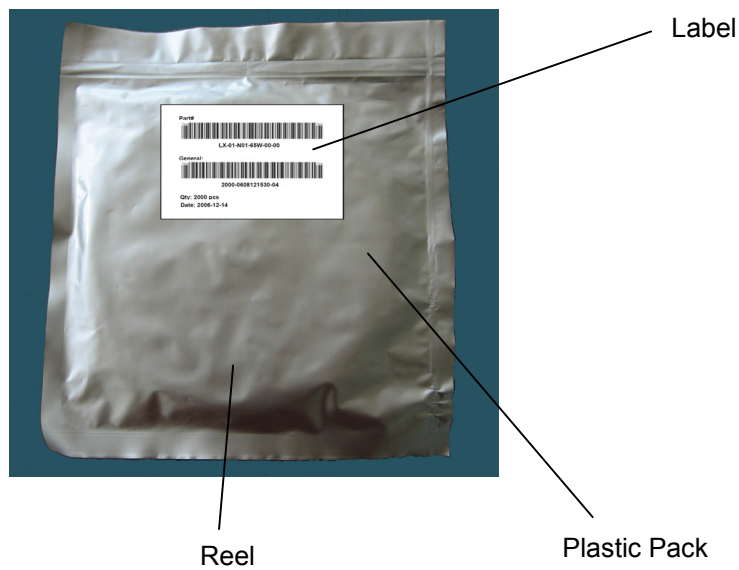
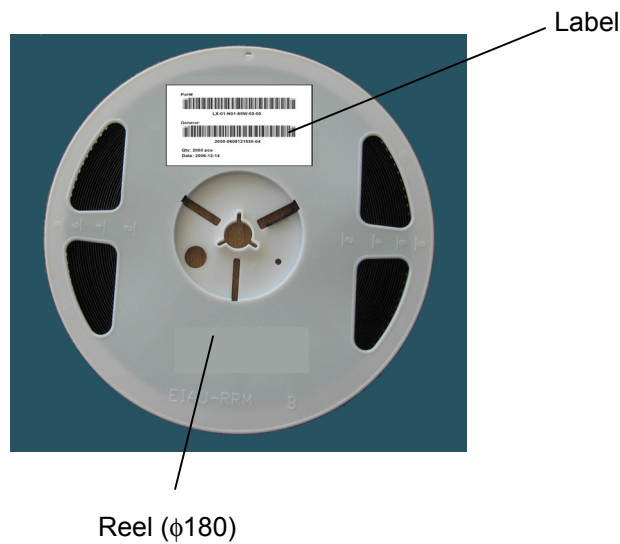



### Description Part Number and Label

Part#	Lexedis		Revision Level		Product	Intensity Rank		Colour			Lens		Packing					
	L	X	-	0	1	N	0	1	-	3	5	W	-	0	0	-	0	0
										4	2	W		4	0			
										6	5	W		6	0			
												R		9	5			
												G						
												B						
Position:	1	2	3	4	5	6	7	8	9	10	11	12	13	14	15	16	17	18

**Legend Part Number:**

Position:	Description:
1 - 2	= Lexedis
4 - 5	= Revision Number
6	= Product: N = nanoXED
7 - 8	= Intensity ranks: 01 = Rank A 02 = Rank B 03 = Rank C XX = Free Rank
10 - 11	= Colour range white: 30 = 3000K 35 = 3500K 42 = 4200K 65 = 6500K
12	= Colour: W = white B = blue R = red G = green
14 - 15	= Lens: 00 = no lens 40 = 40° lens 60 = 60° lens 95 = 95° lens
17 - 18	= Type of packing: 00 = reel 11 = on PCB 99 = bulk

General:	Quantity:				date						time				Operator			
					Y	Y	M	M	D	D	h	h	m	m				
	2	0	0	0	-	0	7	0	1	1	2	1	5	3	0	-	0	4
Position:	1	2	3	4	5	6	7	8	9	10	11	12	13	14	15	16	17	18

**Legend General:**

Position:	Description:
1 - 4	= Quantity LED's in reel
6 - 7	= date: year
8 - 9	= date: month
10 - 11	= date: day
12 - 13	= time: hour
14 - 15	= time: minute
17 - 18	= Operator Code

Lot#:	Production Order Number							lot classification one	lot classification two	lot classification three							
	1	5	3	4	8	2	6	-	0	0	1	0	5	2	0	2	2
Position:	1	2	3	4	5	6	7	8	9	10	11	12	13	14	15	16	17

**Legend Lot Number:**

Position:	Description:
1 - 7	= Production Order Number
8 - 11	= lot classification 1
12 - 14	= lot classification 2
15 - 17	= lot classification 3



## Precautions in Handling

### Safety Precautions

- The XED light output is intense enough to cause injury to human eyes if viewed directly. Precautions must be taken to avoid looking directly at the XEDs with unprotected eyes [according IEC 60825-1 (EN 60825-1)].

### Protection against electrostatic discharge – ESD

- XEDs are electronic components and sensitive to electrostatic discharge. Appropriate ESD protection measures must be taken when working with XED products. For example, earthed shoes or ESD wristbands have to be applied. Non-compliance with ESD protection measures may lead to damage or destruction of the product.

### Precaution in driving

- Products are designed exclusively for forward current driving. Please avoid driving system with reverse voltage, which may cause migration which damages the product.

### Baking

- If the moisture absorbent material (silica gel) is no longer effective or the products have exceeded the storage time, baking treatment should be performed under the following condition:
- Baking treatment : more than 12 hours at  $60\pm 5^{\circ}\text{C}$ .

### Cleaning

- Chemical solvents or cleaning agents must not be used to clean the XED component. Mechanical stress on the XED component must be avoided. It is best to use a soft brush, damp cloth or low-pressure compressed air.

### Storage

- XEDs should ideally be stored in as-delivered condition and in the original packaging. The products should be stored away from direct light in dry location.
- After opening the package:  
The XEDs should be kept at  $30^{\circ}\text{C}$  or less and 70%RH or less. The XEDs should be soldered within 12 hours after opening the package. If unused XEDs remain, they should be stored in the moisture proof packages, such as sealed containers with packages of moisture absorbent material (silica gel). It is also recommended to return the XEDs to the original moisture proof bag and to reseal the moisture proof bag again.
- Please avoid rapid transitions in ambient temperature, especially in high humidity environments where condensation could occur.



#### **Company information:**

LEXEDIS Lighting GmbH, a joint venture company between TridonicAtco of Austria and Toyoda Gosei of Japan, invents and produces innovative and high-performance digital light sources marketed worldwide under the XED brand. Founded in 2005, LEXEDIS is a fast-growing and customer-oriented company providing advanced opto-semiconductor products for the advancement of energy-efficient lighting solutions in automotive, general lighting, industrial and display applications. As the creator of XED technology, LEXEDIS is the leading company in the development of intelligent light sources.

For technical assistance or the location of your nearest customer-service office contact the following :

**LEXEDIS Lighting GmbH**  
Technologiepark 10  
A-8380 Jennersdorf  
Austria  
Tel No:0043-(0)5-9010-650-00  
0043-(0)5572-395-3814

Product specifications are subject to change without notice. XED is a registered trademark of Lexedis lighting GmbH in Europe and other countries.