

Outdoor Thermoelectric Cooler Assemblies

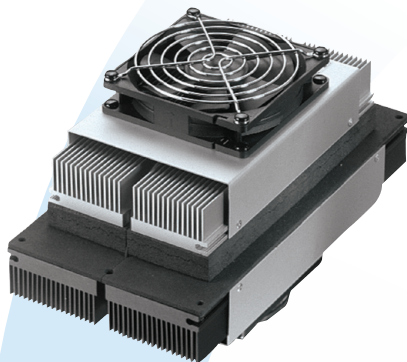

THERMOELECTRIC COOLING UNITS FOR OUTDOOR ENCLOSURES AND KIOSKS

The AA Outdoor Cooler Series is an Air-to-Air thermoelectric assembly (TEA) that uses impingement flow to transfer heat. It offers dependable, compact performance by cooling objects via convection. Heat is absorbed and dissipated thru high density heat exchangers equipped with air ducted shrouds and brand name fans. The heat pumping action occurs from custom designed thermoelectric modules that achieve a high coefficient of performance (COP) to minimize power consumption.

This product series has been designed to pass rigorous Telcordia test requirements conducted by our customers, such as earthquake resistance, salt fog, wind-driven rain, high temperature exposure and dust contaminants. This is due to the selection of world class components such as brand fans with the highest degree of environmental protection and lifetime guaranteed waterproof connectors, heavy duty anodization on the high-density heat sinks, overheat protection, and double environmental seals for the thermoelectric modules.

FEATURES AND BENEFITS

- 200W capacity rated at $\Delta T = 0^{\circ}\text{C}$, $T_{\text{ambient}} = 32^{\circ}\text{C}$
- Wide operating temperature range of -40°C to $+55^{\circ}\text{C}$
- Telcordia GR-487-CORE tested and verified by customers when integrated in telecom outdoor enclosures
- Gaskets, connectors, and fans provide a NEMA 4 seal for the enclosure
- UL60950 and UL50 approval obtained by customers when integrated in telecom outdoor enclosures
- Environmentally friendly solid state operation – no compressor or CFC refrigerants
- Cooling and heating in the same unit; optional temperature controller reverses the polarity of current to generate heating

APPLICATIONS

- Outdoor telecom enclosures
- Outdoor kiosks and displays
- Harsh condition electronic cabinets
- Battery cabinets

global solutions: local support™

Americas: +1.888.246.9050

Europe: +46.31.704.67.57

Asia: +86.755.2714.1166

CLV-customerservice@lairdtech.com

www.lairdtech.com/thermal

PERFORMANCE Q_c VS ΔT

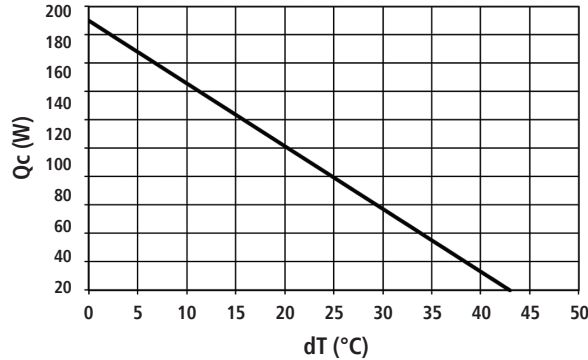

SPECIFICATIONS	AA-200-24-44-00-XX
Technical	
Technology	Thermoelectric (TE) modules, forced air, closed loop (non-mixing), filterless, non-refrigerant
Cooling at $dT = 0^\circ\text{C}$, and nominal / float voltage. ¹	193/214W (659/731 Btu/h)
Heating ²	250W (853 Btu/h)
Voltage (nominal / maximum)	24/28 VDC
Grounding (all voltages)	Positive or negative
Current draw, $\pm 10\%$ (nominal / startup)	11.3/14.3 A (24V version)
Weight	6.6 kg (14.5 lbs)
Panel mounting	Through
Fan life (L_{10} at $+40^\circ\text{C}$)	$\geq 70,000$ hours
Number of connectors	3
Connector type (on unit / mating side)	On unit: AMP part number: 350777-1, 794269, 350547-6, 794270-1 Mating side: AMP part number : 350778-1, 350550-6, 794270-1
Hi-pot testing	707 VDC
Environmental	
Temperature range ³ (external ambient)	-40°C to $+55^\circ\text{C}$ (-40°F to $+131^\circ\text{F}$)
Temperature range (internal enclosure)	-20°C to $+55^\circ\text{C}$ (-4°F to $+131^\circ\text{F}$)
Degree of protection, enclosure ⁴	NEMA 4 (IP55)
Degree of protection, unit ⁵	IP54
Sound level (1m distance)	63 dB(A)
Over-Temp Thermostat (Hot and cold side heat sink)	$80^\circ\text{C} \pm 3^\circ\text{C}$

¹ Cooling capacities at nominal / float voltage are rated at external temperatures of 32°C and 46°C respectively. Float voltage is defined at 27 VDC

² Heating capacity is rated at external temperature of -40°C , nominal voltage, and $dT = -45^\circ\text{C}$.

³ Controller function shall not operate the external fan during heating mode.

⁴ The highest environmental protection level requires an external shroud and is defined as the protection level for the enclosure.

⁵ Rating for unit without protective shroud.

Note: The specified performance of any Laird Technologies cooling unit is dependent on how it is handled and incorporated into the final product. This includes elements such as the system design, insulation design, and assembly method. While Laird Technologies is able to provide general guidelines based upon our experience, it is ultimately the responsibility of the device manufacturer to validate each product and its performance for its intended use.

AA-200-24-44-00-XX Outdoor Thermoelectric Cooler Assemblies

ISOMETRIC DRAWINGS

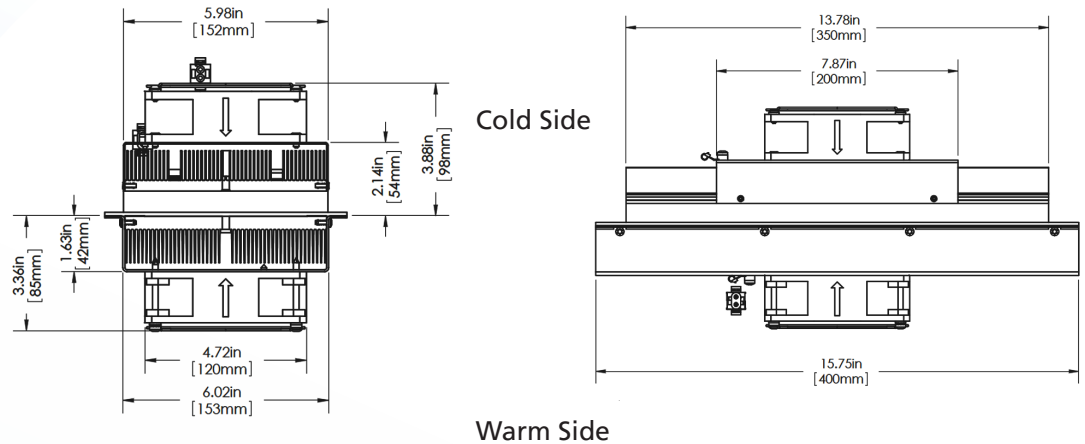

MOUNTING HOLE LOCATION

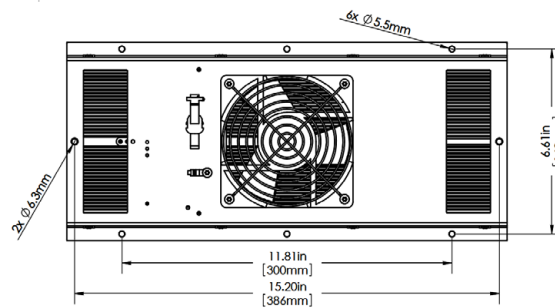

WIRING SCHEMATIC

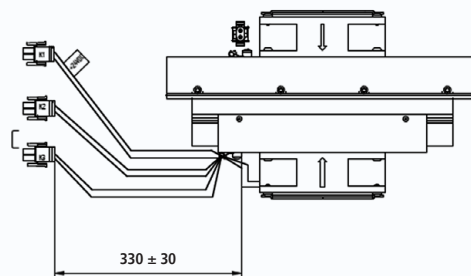

Electrical connections

- K1 Power to TEM Array (Operate in Cooling Mode)
 - P1 Positive (Red) Marked +24 VDC
 - P2 Negative (Black)
- K2 Power to Exterior Fan (Hot Side)
 - P1 Positive (Orange) +24 VDC
 - P2 Negative (White)
- K3 Power to Interior Fan (Cold Side)
 - P1 Positive (Green)
 - P2 Negative (White)