

Additional Hardware Information

MOUNTING NUTS

MNU-1M01A

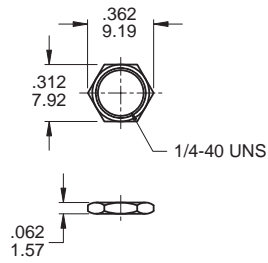

MNU-1M04

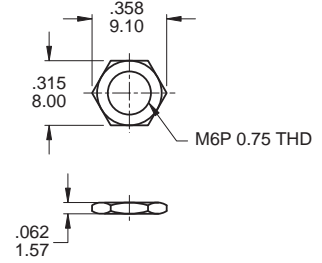

MNU-1M07

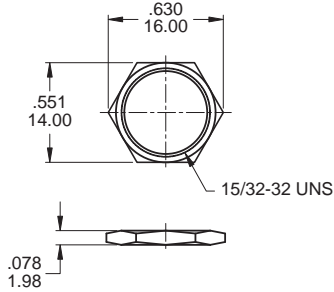

MNU-1M41

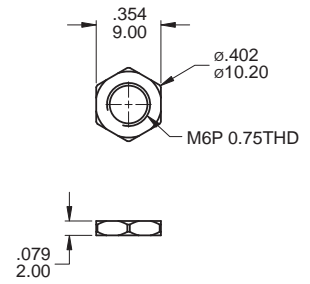

MNU-2M01

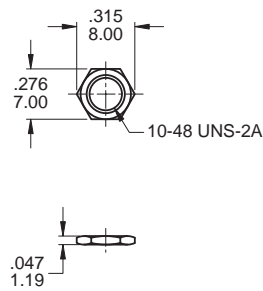

MNU-7M01

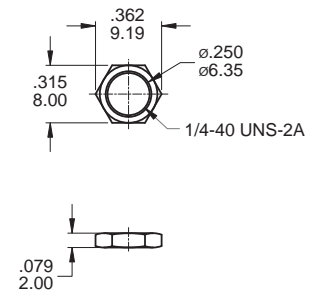

MNU-PA01

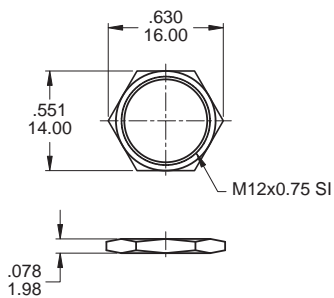

MNU-PA03

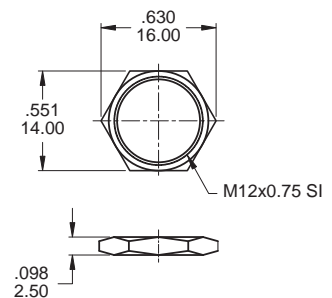

DRESS NUTS

MNU-1M17

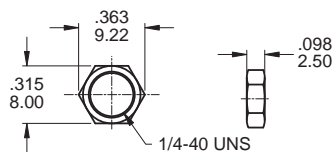

MNU-1M18

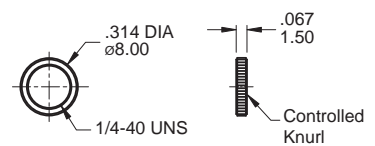

HARDWARE

MNU-1M19

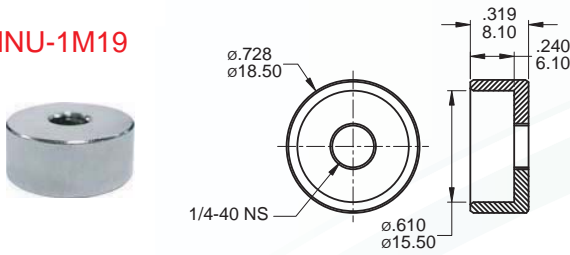

MNU-1M20

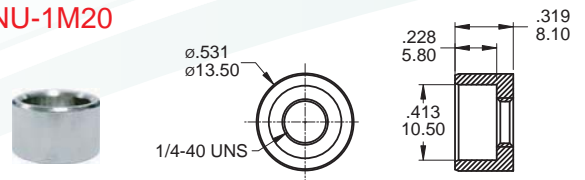

MNU-1M21

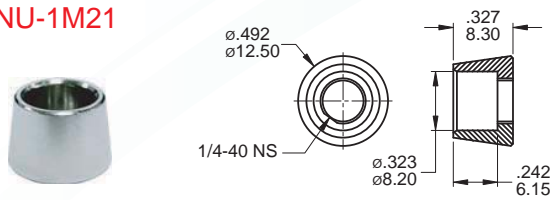

MNU-1M24

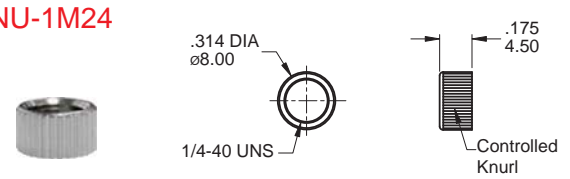

MNU-1M29

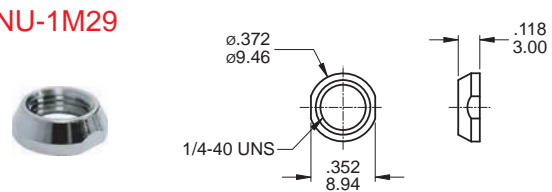

MNU-1M32

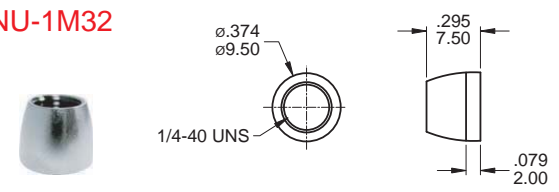

MNU-1M16

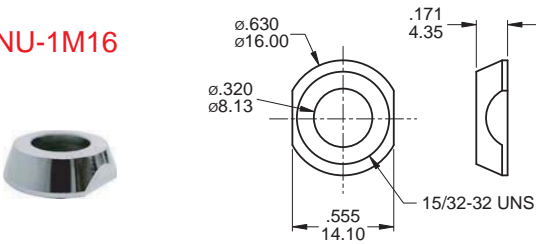

MNU-1M48

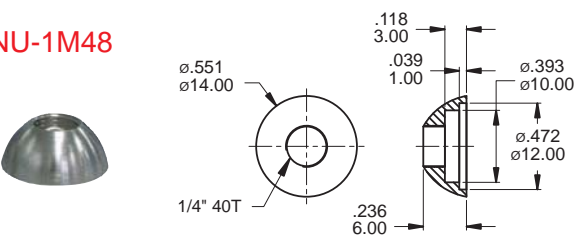

MNU-1825621-1

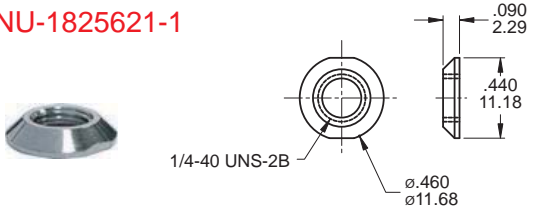

MNU-1825621-2

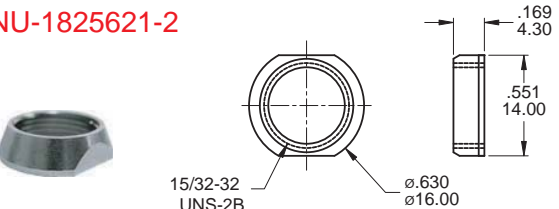

MNU-1825623-1

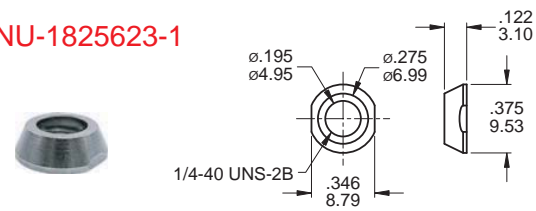

MNU-1825623-3

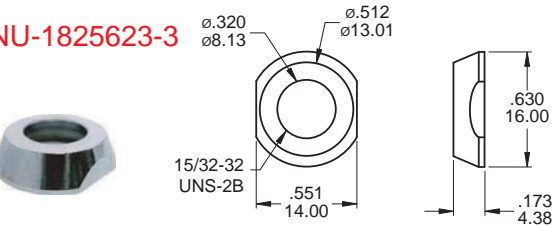

MNU-1825622-1

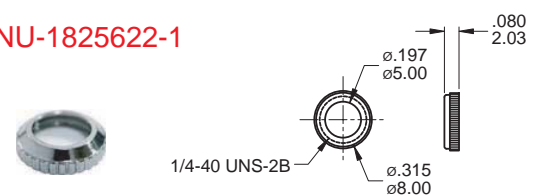

MNU-1825622-2

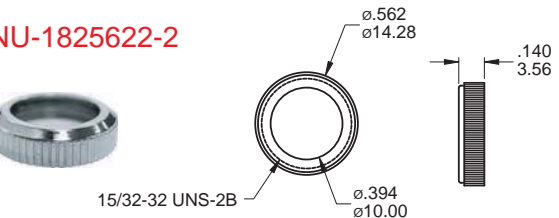

Additional Hardware Information

Additional Hardware Information

LOCKING RINGS

MNU-1M02

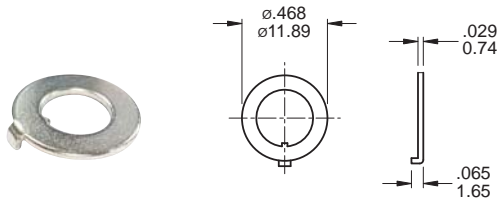

MNU-1M05

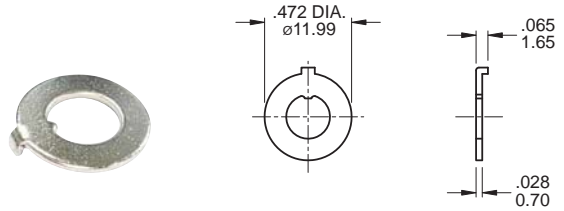

MNU-1M08

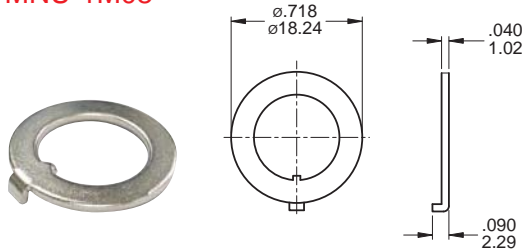

MNU-1M11

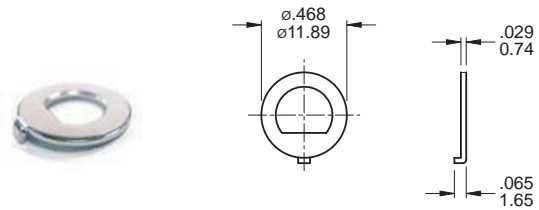

MNU-1M02P

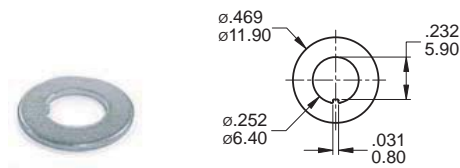

MNU-2M0B

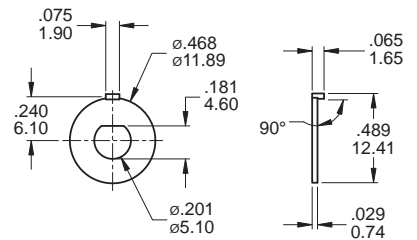

LOCKWASHER

MNU-1M03

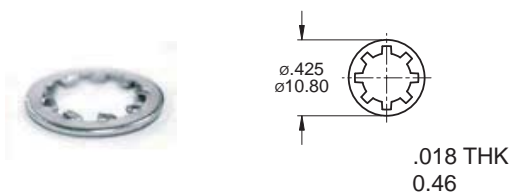

MNU-1M09

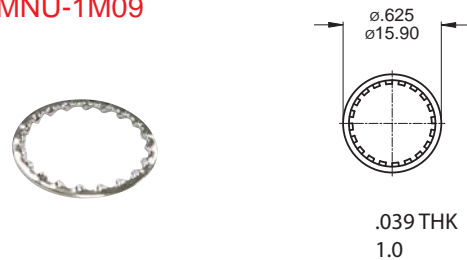

MNU-2M03

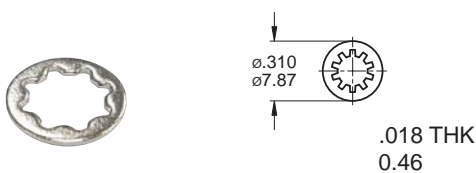

MNU-1M27



HARDWARE

NAMEPLATE

MNU-1M10

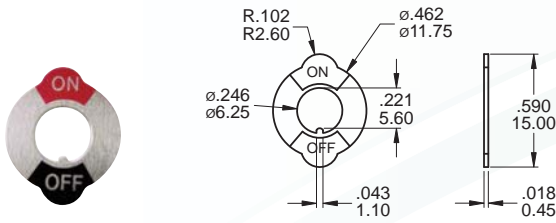

MNU-1M22

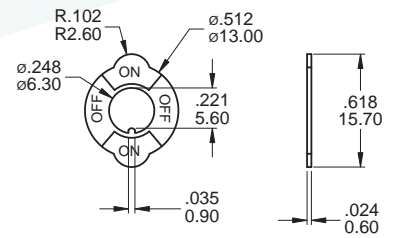

RUBBER - HOOD

E1-RUBBER-HOOD
K1-RUBBER-HOOD

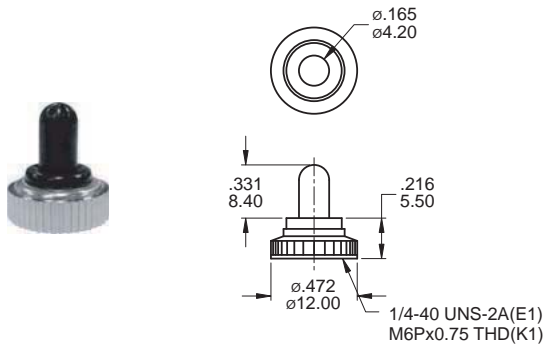

E4-RUBBER-HOOD
K4-RUBBER-HOOD

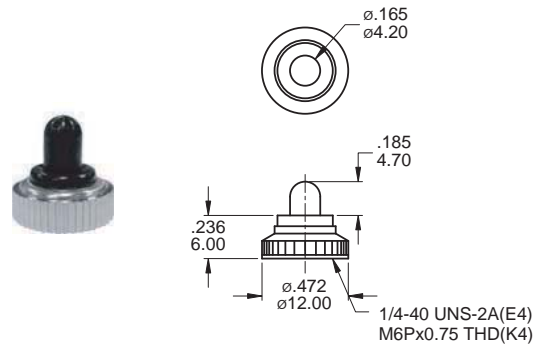

PF2-RUBBER-HOOD
*Si-20°

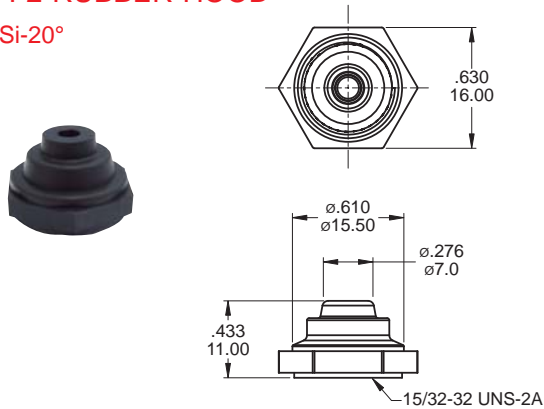

MCP-P003-2
(Black cap)

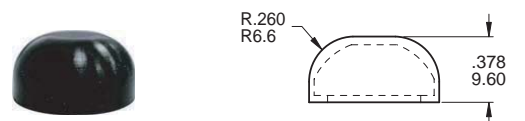

MCP-P003
(Transparent cap)

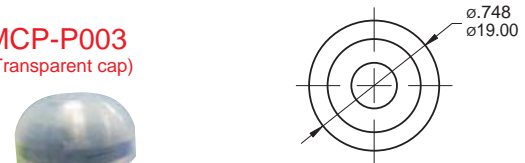

* Supplied with PA series

PG1-RUBBER-HOOD

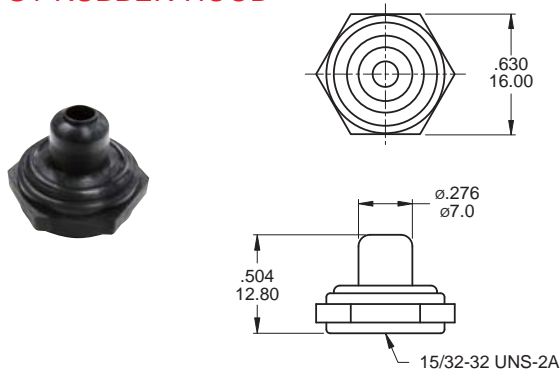

PG2A-RUBBER-HOOD

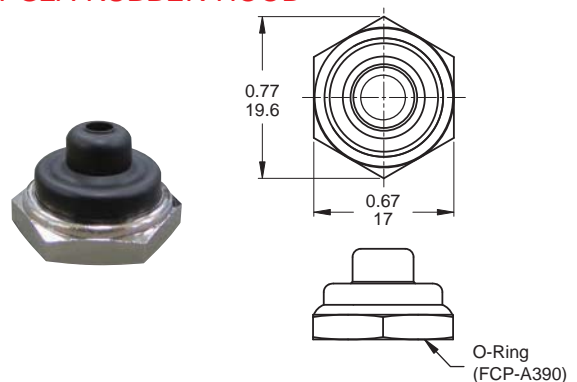

Additional Hardware Information

RUBBER - HOOD

PU2-ET-102

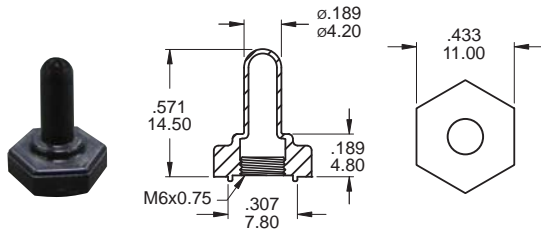

PU2-WB-A7A

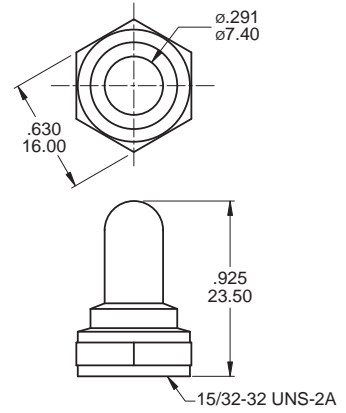

PLAN & MEMO

Blank area for plan and memo with horizontal dashed lines.