

HOW TO ORDER

SPECIFICATIONS

- MAXIMUM RATING :** 50VDC. 100mA.
- MINIMUM RATING :** 20VDC. 10A.
- CONTACT RESISTANCE :** 100mΩ MAX.
- INSULATION RESISTANCE :** 100VDC-1000M MIN.
- WITHSTAND VOLTAGE :** 250VAC-1 MINUTE
- ROTARY TORQUE :** 40~200gf.cm
- TOTAL ROTARY ANGLE :** 360° (4,10,16 STEPS)
- LIFE CYCLE :** 10,000 STEPS

RSC - 1 A R M

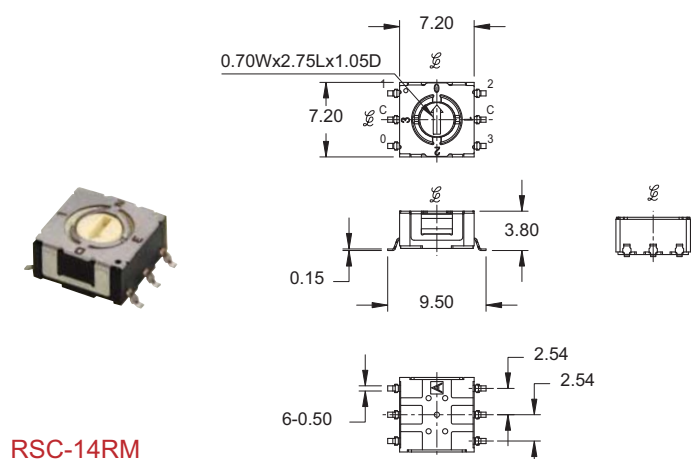
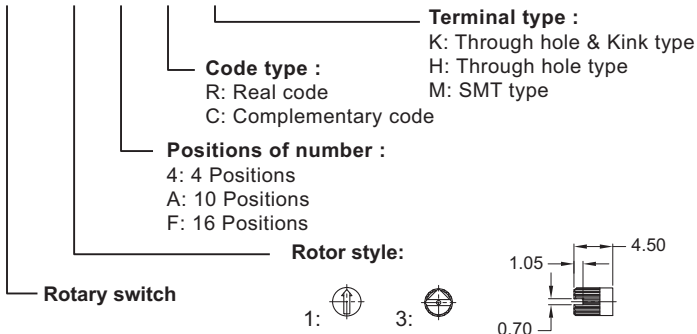

RSC-14RM

CIRCUIT CHART

POSITIONS	CODE				
	C	0	1	2	3
0	•	•	•	•	•
1	•	•	•	•	•
2	•	•	•	•	•
3	•	•	•	•	•

P.C.B. LAYOUT

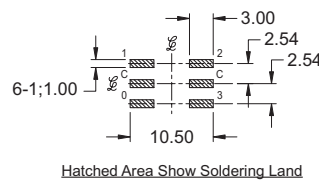

NO.	PART NAME	MATERIAL	QTY	FINISHING
1	FRAM	LCP+G	1	
2	COVER	SUS	1	
3	ROTOR	PA+G	1	Au PLATED
4	TERMINAL	PBS	6	Au PLATED
5	CONTACT PLATE	BeCu	1	
6	O-RING	SILICONE RUBBER	1	
7	SPACER	SUS	1	

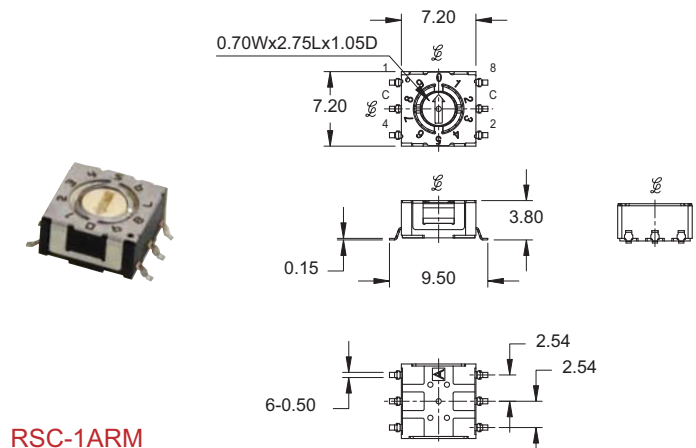

RSC-1ARM

CIRCUIT CHART

POSITIONS	CODE				
	C	1	2	4	8
0	•	•	•	•	•
1	•	•	•	•	•
2	•	•	•	•	•
3	•	•	•	•	•
4	•	•	•	•	•
5	•	•	•	•	•
6	•	•	•	•	•
7	•	•	•	•	•
8	•	•	•	•	•
9	•	•	•	•	•

P.C.B. LAYOUT

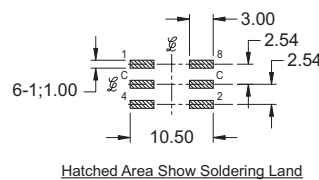

NO.	PART NAME	MATERIAL	QTY	FINISHING
1	FRAM	LCP+G	1	
2	COVER	SUS	1	
3	ROTOR	PA+G	1	Au PLATED
4	TERMINAL	PBS	6	Au PLATED
5	CONTACT PLATE	BeCu	1	
6	O-RING	SILICONE RUBBER	1	
7	SPACER	SUS	1	

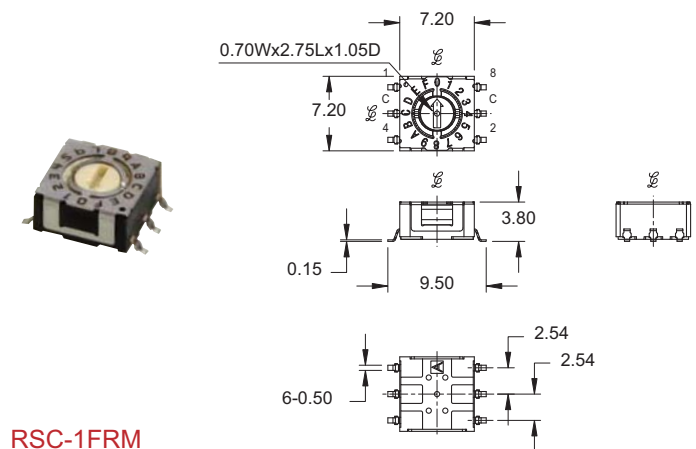

RSC-1FRM

CIRCUIT CHART

POSITIONS	CODE				
	C	1	2	4	8
0	•	•	•	•	•
1	•	•	•	•	•
2	•	•	•	•	•
3	•	•	•	•	•
4	•	•	•	•	•
5	•	•	•	•	•
6	•	•	•	•	•
7	•	•	•	•	•
8	•	•	•	•	•
9	•	•	•	•	•
A	•	•	•	•	•
B	•	•	•	•	•
C	•	•	•	•	•
D	•	•	•	•	•
E	•	•	•	•	•
F	•	•	•	•	•

P.C.B. LAYOUT

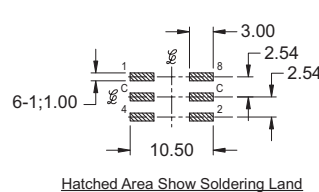

NO.	PART NAME	MATERIAL	QTY	FINISHING
1	FRAM	LCP+G	1	
2	COVER	SUS	1	
3	ROTOR	PA+G	1	Au PLATED
4	TERMINAL	PBS	6	Au PLATED
5	CONTACT PLATE	BeCu	1	
6	O-RING	SILICONE RUBBER	1	
7	SPACER	SUS	1	



RSC-24RM

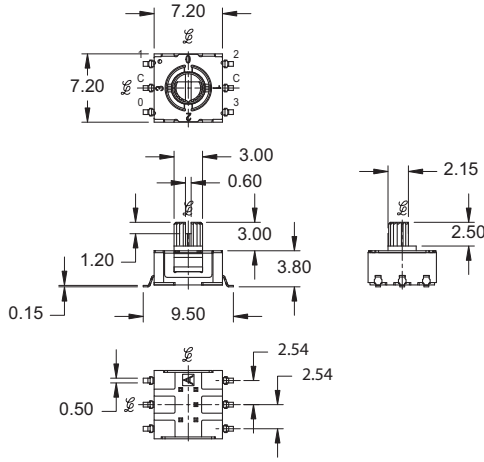

CIRCUIT CHART



P.C.B. LAYOUT

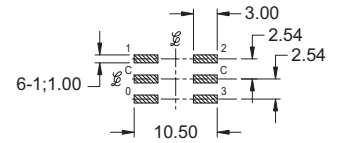

Hatched Area Show Soldering Land

NO.	PART NAME	MATERIAL	QTY	FINISHING
1	FRAM	PA+G	1	
2	COVER	SUS	1	
3	ROTOR	LCP+G	1	Au PLATED
4	TERMINAL	PBS	6	Au PLATED
5	CONTACT PLATE	BeCu	1	
6	O-RING	SILICONE RUBBER	1	
7	SPACER	SUS	1	



RSC-34RM

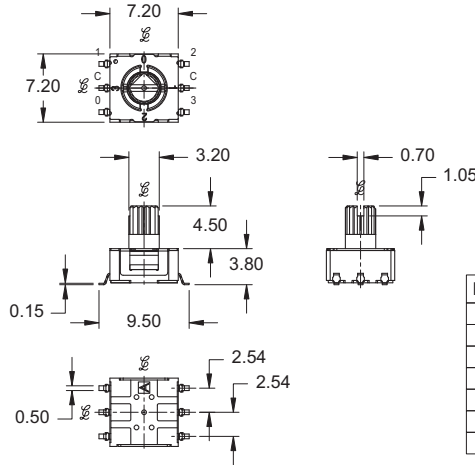

CIRCUIT CHART



P.C.B. LAYOUT

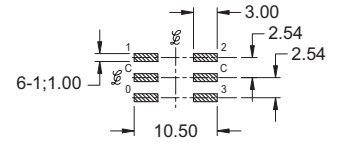

Hatched Area Show Soldering Land

NO.	PART NAME	MATERIAL	QTY	FINISHING
1	FRAM	LCP+G	1	
2	COVER	SUS	1	
3	ROTOR	PA+G	1	Au PLATED
4	TERMINAL	PBS	6	Au PLATED
5	CONTACT PLATE	BeCu	1	
6	O-RING	SILICONE RUBBER	1	
7	SPACER	SUS	1	



RSC-3ARM

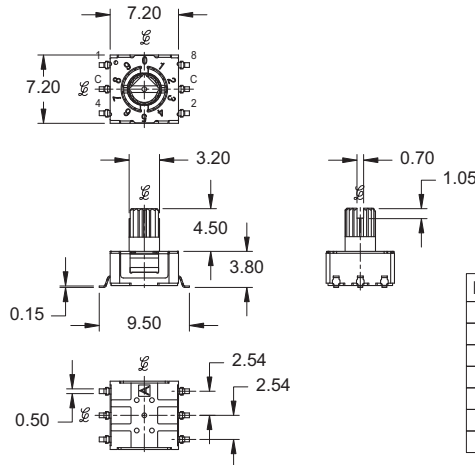

CIRCUIT CHART

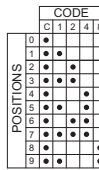

P.C.B. LAYOUT

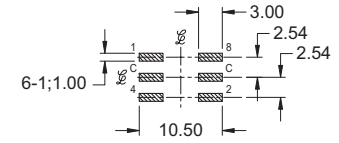

Hatched Area Show Soldering Land

NO.	PART NAME	MATERIAL	QTY	FINISHING
1	FRAM	LCP+G	1	
2	COVER	SUS	1	
3	ROTOR	PA+G	1	Au PLATED
4	TERMINAL	PBS	6	Au PLATED
5	CONTACT PLATE	BeCu	1	
6	O-RING	SILICONE RUBBER	1	
7	SPACER	SUS	1	



RSC-3FRM

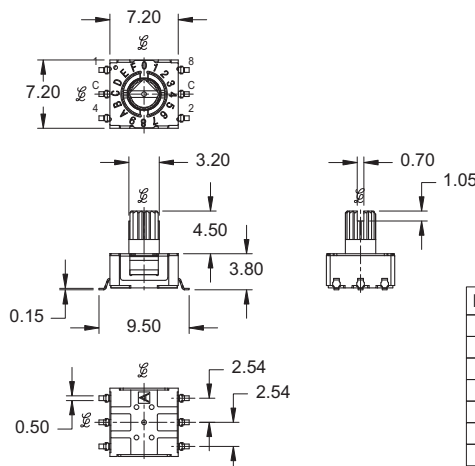

CIRCUIT CHART

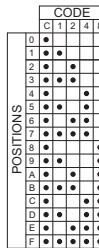

P.C.B. LAYOUT

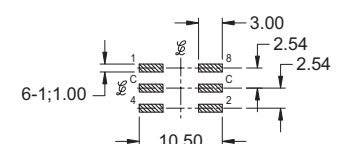

Hatched Area Show Soldering Land

NO.	PART NAME	MATERIAL	QTY	FINISHING
1	FRAM	LCP+G	1	
2	COVER	SUS	1	
3	ROTOR	PA+G	1	Au PLATED
4	TERMINAL	PBS	6	Au PLATED
5	CONTACT PLATE	BeCu	1	
6	O-RING	SILICONE RUBBER	1	
7	SPACER	SUS	1	