

### General Specifications

Current Rating	:50mA
Voltage Rating	:12VDC
Dielectric Withstanding Voltage	:250VAC for 1 minute
Contact Resistance	:100m Ohm Max.(initial)
Insulation Resistance	:100M Ohm Min.
Operating Force	:200gf ± 50gf
Total Travel	:0.3mm ± 0.1mm
Operating Life	:1,000,000 cycles Min.
Solder Specifications	:260 deg. for 3 seconds
Function	:Momentary(SPST)
Operating Temperature	:-10 deg.~+60 deg.

### Materials

Cap	:Polycarbonate (PC)
Base	:Polyamide (PA)
Reflector	:Polyamide (PA)
Switch Terminal	:Brass with gold plating
Action Dome	:Stainless steel with silver plating
Sealing rubber	:Silicone

## HOW TO ORDER

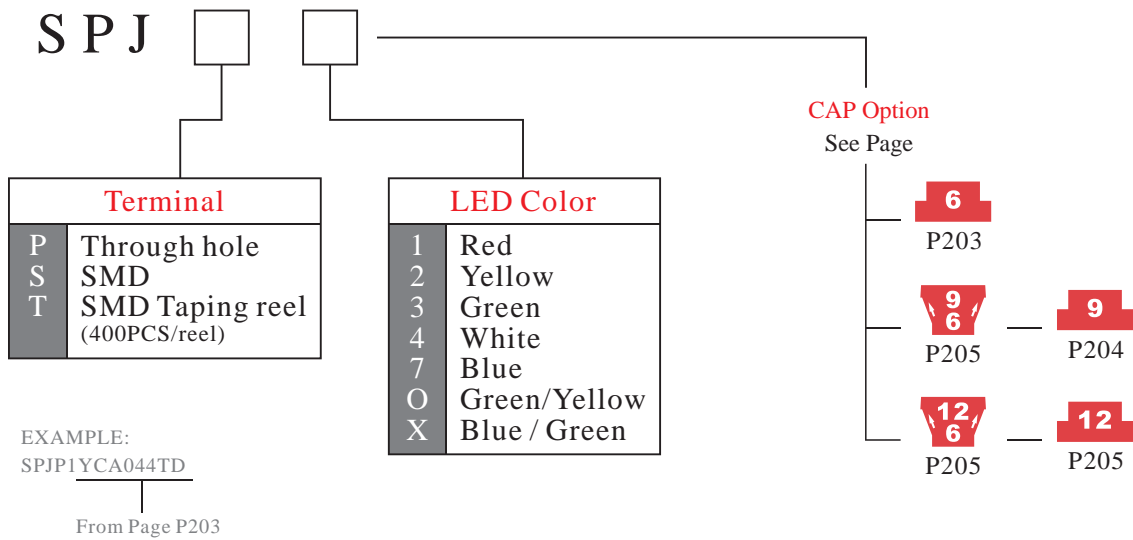

### Circuit Diagram

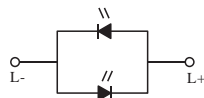

SPJ tact switch  
Dual Colors LED only

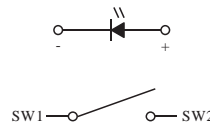

Through hole type - SPJ-P

SMD type - SPJ-S

### PCB layout

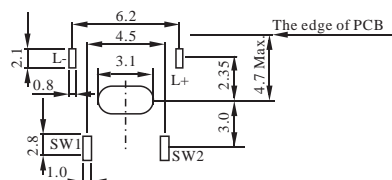
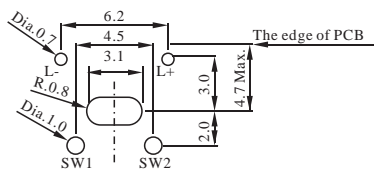

**POLE OPTIONS**

Dimension-Through hole type

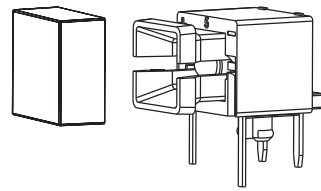
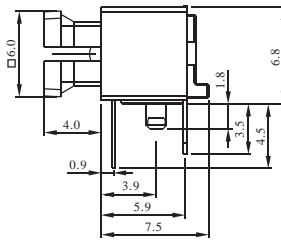
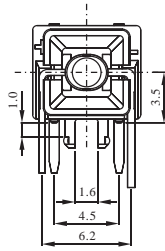

Note:  
\*Fit cap **AFTER** soldering process.

Dimension - SMD type

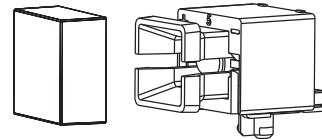
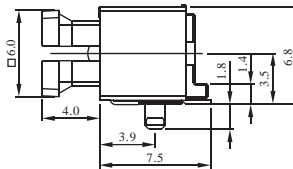
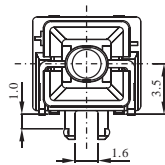

Note:  
\*Fit cap **AFTER** soldering process.

**TAPING REEL DIMENSION**

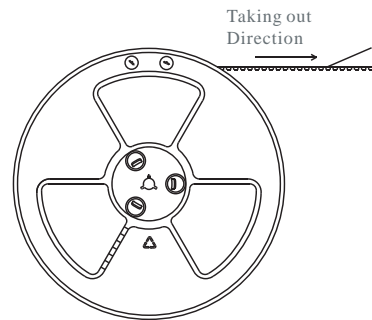
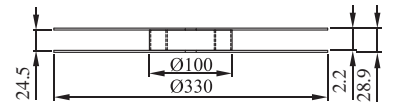
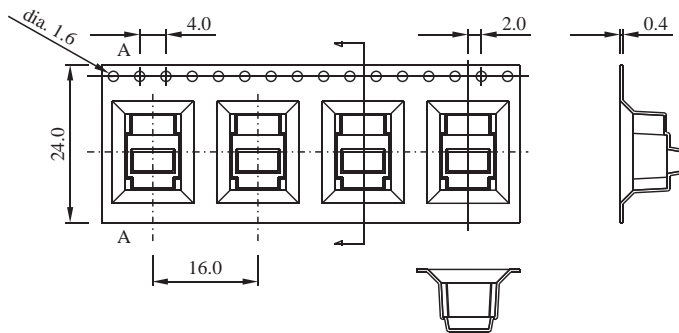

Component loaded per 13" reel: 400 Pcs(Core 4")