

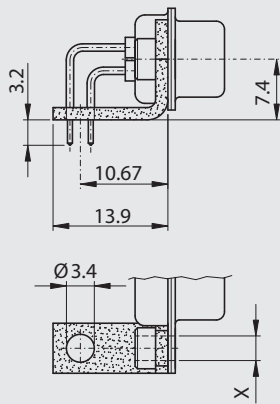

M46 x



Metallwinkel / Metal bracket

M46 D3	Niete / rivet	Ø 3.1 mm
M46 UN	Niete / back nut	UNC4-40
M46 M3	Niete / back nut	M3

M46 xx

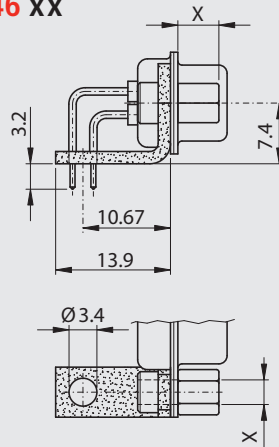

Metallwinkel / Metal bracket

M46 UN B5	Niete / back nut	UNC4-40
	Schraube / screw	5 mm
M46 UN B6	Niete / back nut	UNC4-40
	Schraube / screw	6 mm
M46 M3 B5	Niete / back nut	M3
	Schraube / screw	5 mm
M46 M3 B6	Niete / back nut	M3
	Schraube / screw	6 mm

M47 x

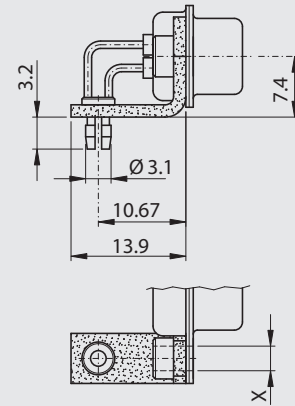

Metallwinkel mit P.o.F.
Metal bracket with P.o.F.

M47 D3	Niete / rivet	Ø 3.1 mm
M47 UN	Niete / back nut	UNC4-40
M47 M3	Niete / back nut	M3

M47 xx

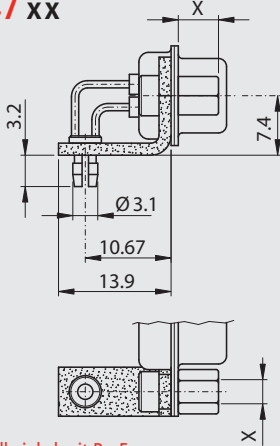

Metallwinkel mit P.o.F.
Metal bracket with P.o.F.

M47 UN B5	Niete / back nut	UNC4-40
	Schraube / screw	5 mm
M47 UN B6	Niete / back nut	UNC4-40
	Schraube / screw	6 mm
M47 M3 B5	Niete / back nut	M3
	Schraube / screw	5 mm
M47 M3 B6	Niete / back nut	M3
	Schraube / screw	6 mm

M48 x

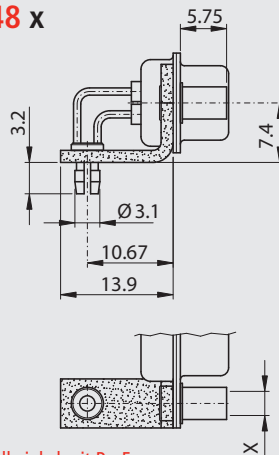

Metallwinkel mit P.o.F.
Metal bracket with P.o.F.

M48 UN	Niete / front nut	UNC4-40
M48 M3	Niete / front nut	M3

M49 x

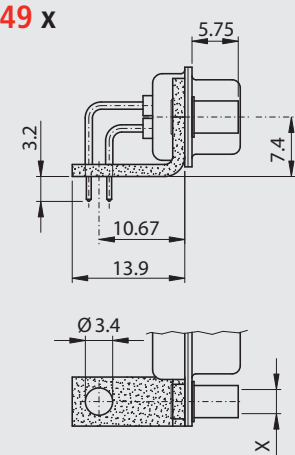

Metallwinkel / Metal bracket

M49 UN	Niete / front nut	UNC4-40
M49 M3	Niete / front nut	M3

Montagearten (FT)

Bauhöhe 7.4 mm für Lötstift 90°, 9.4 mm (YC)

Assemblies (FT)

Mounting height 7.4 mm for solder pin 90°, 9.4 mm (YC)

M63 x

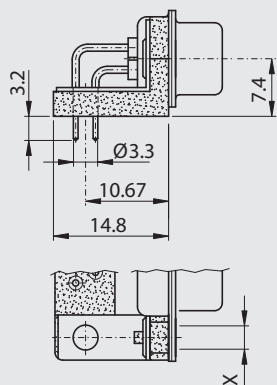

Kunststoffwinkel mit Erdungswinkel
Plastic bracket with ground strap

M63 D3 Niete / rivet Ø 3.1 mm

M63 UN Niete / back nut UNC4-40

M63 M3 Niete / back nut M3

M63 xx

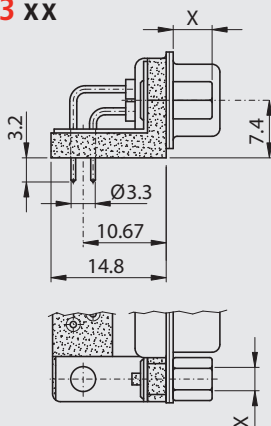

Kunststoffwinkel mit Erdungswinkel
Plastic bracket with ground strap

M63 UN B5 Niete / back nut UNC4-40

Schraube / screw 5 mm

M63 UN B6 Niete / back nut UNC4-40

Schraube / screw 6 mm

M63 M3 B5 Niete / back nut M3

Schraube / screw 5 mm

M63 M3 B6 Niete / back nut M3

Schraube / screw 6 mm

M64 x

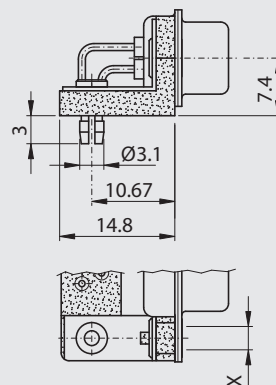

Kunststoffwinkel mit Erdungswinkel und P.o.F.
Plastic bracket with ground strap and P.o.F.

M64 D3 Niete / rivet Ø 3.1 mm

M64 UN Niete / back nut UNC4-40

M64 M3 Niete / back nut M3

M64 xx

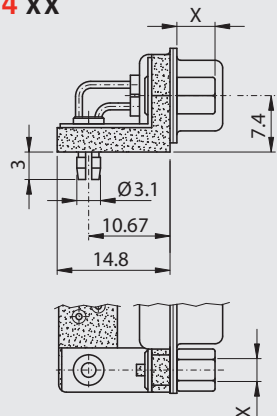

Kunststoffwinkel mit Erdungswinkel und P.o.F.
Plastic bracket with ground strap and P.o.F.

M64 UN B5 Niete / back nut UNC4-40

Schraube / screw 5 mm

M64 UN B6 Niete / back nut UNC4-40

Schraube / screw 6 mm

M64 M3 B5 Niete / back nut M3

Schraube / screw 5 mm

M64 M3 B6 Niete / back nut M3

Schraube / screw 6 mm

M61 x

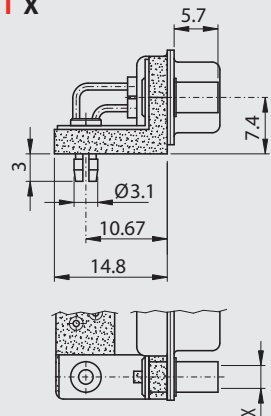

Kunststoffwinkel mit Erdungswinkel und P.o.F.
Plastic bracket with ground strap and P.o.F.

M61 UN Niete / front nut UNC4-40

M61 M3 Niete / front nut M3

M66 x

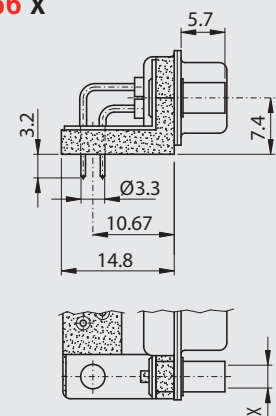

Kunststoffwinkel mit Erdungswinkel
Plastic bracket with ground strap

M66 UN Niete / front nut UNC4-40

Niete / front nut M3

Die Montagen M64 x(x) und M61 x sind auch mit Z-Shape erhältlich. Assemblies M64 x(x) and M61 x are available also with z-shape.

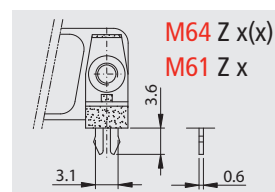



Montagearten (FT)

Bauhöhe 7.4 mm für Lötstift 90°, 9.4 mm (YC)

Assemblies (FT)

Mounting height 7.4 mm for solder pin 90°, 9.4 mm (YC)

M74 x

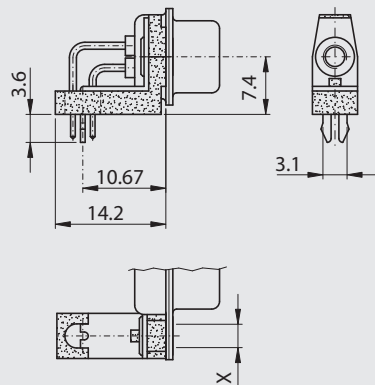

Kunststoffwinkel mit Erdungswinkel (Z)
Plastic bracket with ground strap (Z)

M74 UN Niete / back nut UNC4-40

M74 M3 Niete / back nut M3

M74 xx

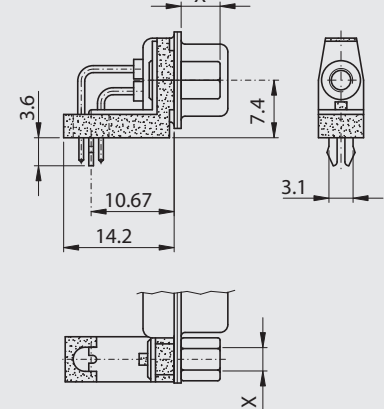

Kunststoffwinkel mit Erdungswinkel (Z)
Plastic bracket with ground strap (Z)

M74 UN B5 Niete / back nut UNC4-40

Schraube / screw 5 mm

M74 UN B6 Niete / back nut UNC4-40

Schraube / screw 6 mm

M74 M3 B5 Niete / back nut M3

Schraube / screw 5 mm

M74 M3 B6 Niete / back nut M3

Schraube / screw 6 mm