

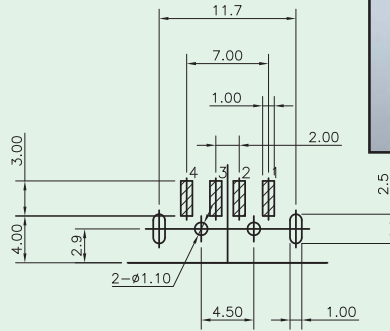

USB Standard-A Plug (SMT TYPE)

KINSUN

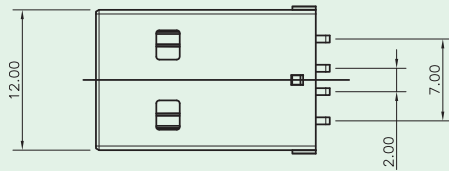

PCB LAYOUT/TOP VIEW

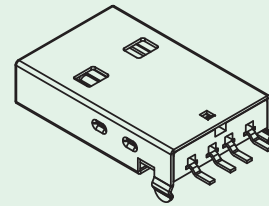
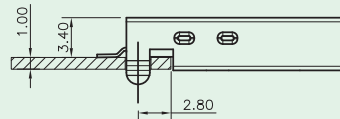
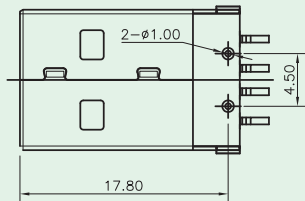
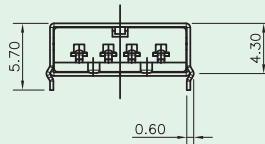
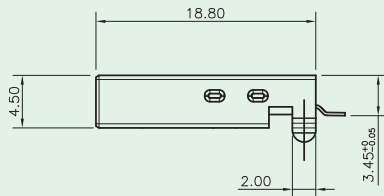

Voltage Rating : 30V AC
 Current Rating : 1.5AMP
 Insulation Resistance : 1000 MΩ Min
 Contact Resistance : 30 mΩ Max
 Dielectric Withstanding Voltage : 500V AC
 Temperature Range : -20°C to +85°C

Materials

- **Plastic Housing** : Engineering Thermoplastic.
Flammability Rating UL 94V-0.
- **Contacts** : Phosphor Bronze.
- **Plating** : Gold Plating Over Nickel In Contact Area.
Tin Plating Over Nickel In Solder Area.
- **Shield** : Steel Plating Nickel.



Ordering Information

6150 - H Series

Series No.

H : Side Entry, SMT