

Technische Daten / Technical Data

Gehäuse <i>Shell</i>	Stahl vernickelt, verzinkt <i>Steel, tin coated over nickel</i>
Isolierkörper <i>Insulator</i>	Thermoplastischer Kunststoff, nach UL94 V-0 <i>Thermoplastic, rated UL94 V-0</i>
Kontaktmaterial <i>Contact Material</i>	Kupferlegierung <i>Copper alloy</i>
Kontaktoberfläche <i>Contact Surface</i>	Gold über Nickel <i>Gold over nickel</i>
Durchgangswiderstand <i>Contact Resistance</i>	< 20mΩ
Isolationswiderstand <i>Insulation Resistance</i>	> 1000MΩ
Spannungsfestigkeit <i>Test Voltage</i>	1kV _{AC}
Nennstrom <i>Current Rating</i>	5A
Temperaturbereich <i>Temperature Range</i>	-55°C ... +125°C
Güteklasse <i>Quality Class</i>	GK 3, min. 50 Steckzyklen, andere GK auf Anfrage <i>Quality class 3, min. 50 cycles, more quality options on request</i>

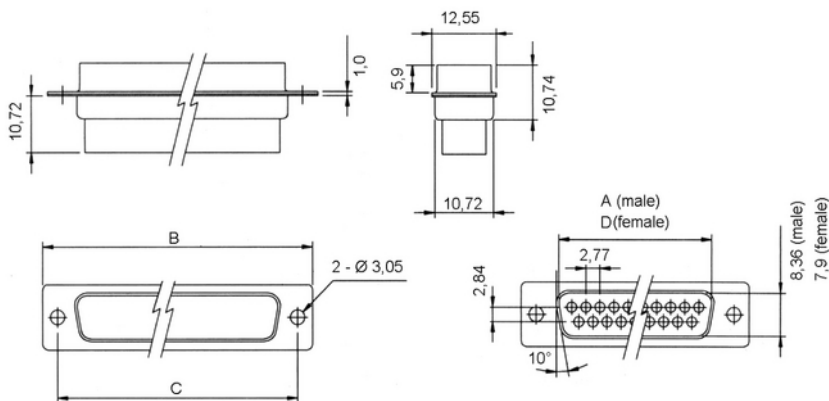
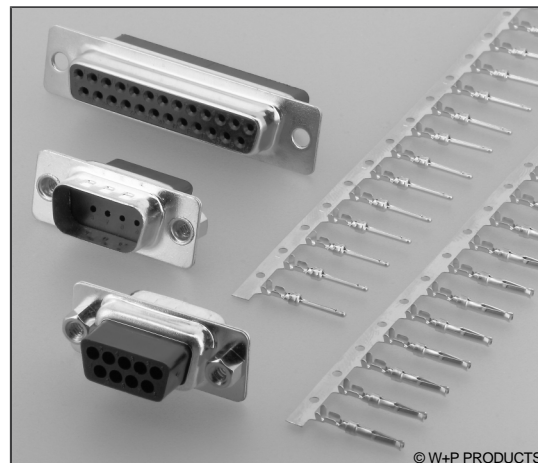

n	A±0.25	B±0.25	C±0.25	D±0.25
09	16.92	30.81	25.00	16.32
15	25.25	39.17	33.32	24.68
25	38.96	53.05	47.04	38.39
37	55.42	69.36	63.50	54.82

Series **115** — **Contacts*** **09** — **Terminal*** **1** — **Mounting*** **0**
Gehäuse **Housing** — **09/15/25/37** — **1 Stift** **Male** — **0-CL Lt. Tech. Info.**
2 Buchse **Female** — **See Tech. Info.**

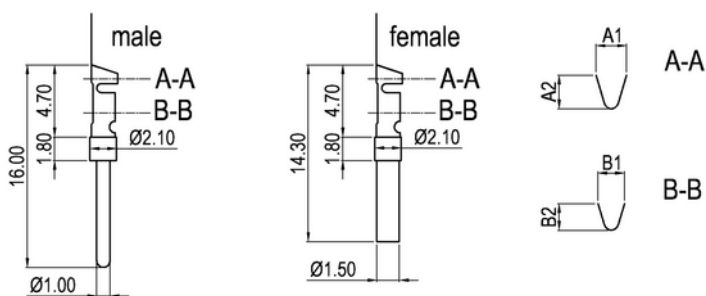

A1±0.05	A2±0.05	B1±0.05	B2±0.05
2.14	2.26	1.75	1.54

Series **115** — **AWG** **24** — **Terminal*** **1** — **Plating** **3** — **Packing** **3**
Kontakte **Contacts** — **24 AWG 24-26** — **1 Stift** **Male** — **3 GK 3 min. 50 Steckzyklen**
2 Buchse **Female** — **Quality Class 3:**
min. 50 cycles — **3 Auf Rolle** **On reel**

* Dies ist ein **Bestellbeispiel** - bitte durch Ihre Spezifikationen ersetzen.
 * This is an **order example** - please replace by your specifications.

Durchgangsloch / Through Hole

0 Durchgangsloch 3,05mm
3.05mm Through Hole

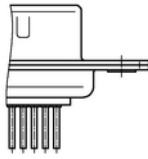

Gewindeniet vorn / Thread Rivet Front

B1 Gewindeniet UNC 4-40
UNC 4-40 Thread Rivet
B2 Gewindeniet M3
M3 Thread Rivet

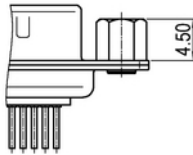

Gewindeniet hinten / Thread Rivet Back

1 Gewindeniet UNC 4-40
UNC 4-40 Thread Rivet
2 Gewindeniet M3
M3 Thread Rivet

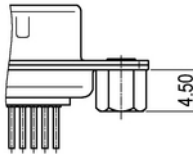

Gewindebolzen vorn / Thread Bolt Front

3 Gewindebolzen UNC 4-40
UNC 4-40 Thread Bolt
4 Gewindebolzen M3
M3 Thread Bolt

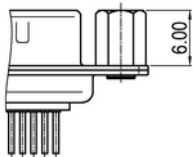

Gewindebolzen hinten / Thread Bolt Back

5 Gewindebolzen UNC 4-40
UNC 4-40 Thread Bolt
6 Gewindebolzen M3
M3 Thread Bolt

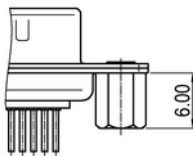

Board Lock

BL Board Lock mit UNC 4-40 Gewinde
Board Lock with UNC 4-40 Thread

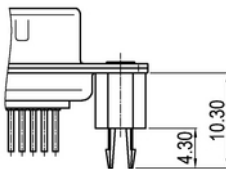

Combi-Lock

CL Combi-Lock mit UNC 4-40 Gewinde
Combi Lock with UNC 4-40 Thread

