

### Technische Daten / Technical Data

Gehäuse <i>Shell</i>	Stahl vernickelt, verzinkt <i>Steel, tin coated over nickel</i>
Isolierkörper <i>Insulator</i>	Thermoplastischer Kunststoff, nach UL94 V-0 <i>Thermoplastic, rated UL94 V-0</i>
Kontaktmaterial <i>Contact Material</i>	Kupferlegierung <i>Copper alloy</i>
Kontaktfläche <i>Contact Surface</i>	Gold über Nickel <i>Gold over nickel</i>
Durchgangswiderstand <i>Contact Resistance</i>	< 20mΩ <i>&lt; 20mΩ</i>
Isolationswiderstand <i>Insulation Resistance</i>	> 500MΩ <i>&gt; 500MΩ</i>
Spannungsfestigkeit <i>Test Voltage</i>	500V <sub>AC</sub> <i>500V<sub>AC</sub></i>
Nennstrom <i>Current Rating</i>	3A <i>3A</i>
Temperaturbereich <i>Temperature Range</i>	-55°C ... +125°C <i>-55°C ... +125°C</i>
Güteklasse <i>Quality Class</i>	GK 3, min. 50 Steckzyklen, andere GK auf Anfrage <i>Quality class 3, min. 50 cycles, more quality options on request</i>

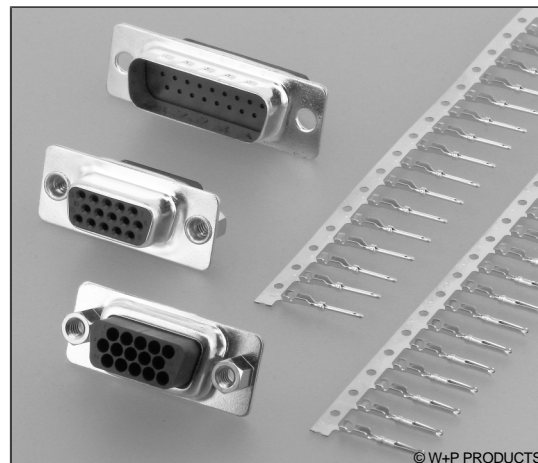

© W+P PRODUCTS

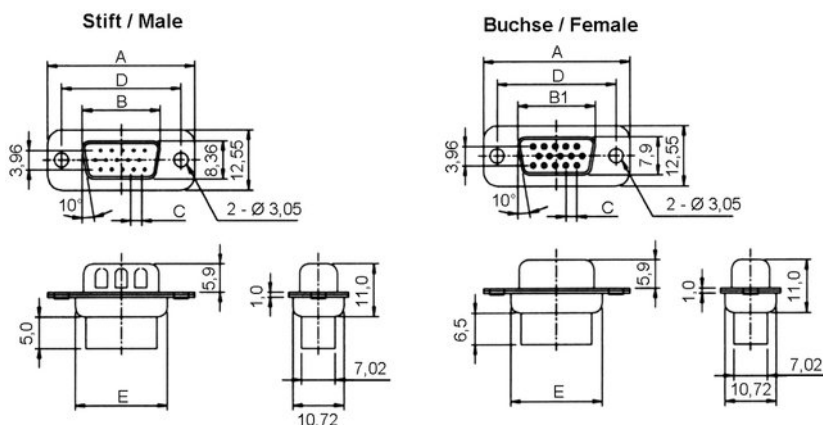

n	A	B	B1	C	D	E
15	30,80	16,92	16,33	2,29	24,99	19,28
26	39,10	25,50	24,66	2,29	33,32	27,51
44	53,00	38,96	36,38	2,29	47,04	41,10
62	69,30	55,42	54,84	2,41	63,50	57,30

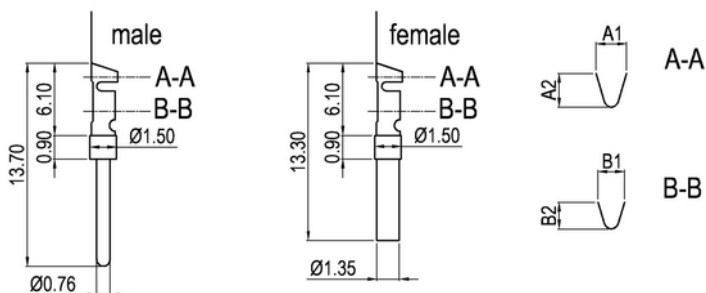

A1±0.10	A2±0.10	B1±0.10	B2±0.10
1.78	1.65	1.32	1.53

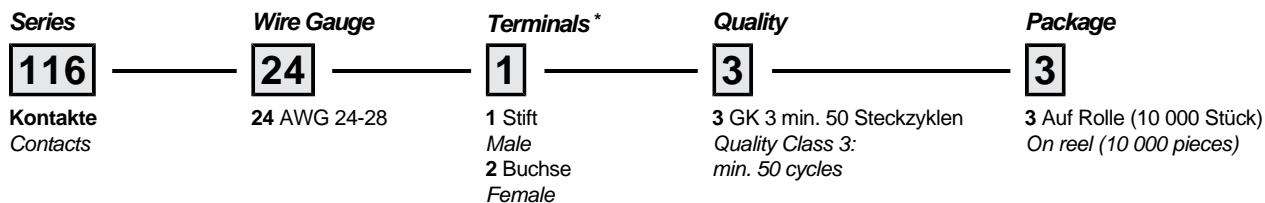

\* Dies ist ein **Bestellbeispiel** - bitte durch Ihre Spezifikationen ersetzen.  
\* This is an **order example** - please replace by your specifications.

## Durchgangsloch / Through Hole

**0** Durchgangsloch 3,05mm  
*3.05mm Through Hole*

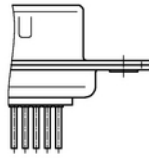

## Gewindeniet vorn / Thread Rivet Front

**B1** Gewindeniet UNC 4-40  
*UNC 4-40 Thread Rivet*  
**B2** Gewindeniet M3  
*M3 Thread Rivet*

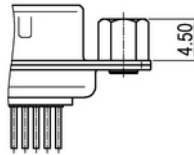

## Gewindeniet hinten / Thread Rivet Back

**1** Gewindeniet UNC 4-40  
*UNC 4-40 Thread Rivet*  
**2** Gewindeniet M3  
*M3 Thread Rivet*

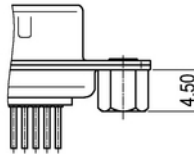

## Gewindebolzen vorn / Thread Bolt Front

**3** Gewindebolzen UNC 4-40  
*UNC 4-40 Thread Bolt*  
**4** Gewindebolzen M3  
*M3 Thread Bolt*

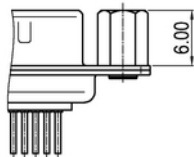

## Gewindebolzen hinten / Thread Bolt Back

**5** Gewindebolzen UNC 4-40  
*UNC 4-40 Thread Bolt*  
**6** Gewindebolzen M3  
*M3 Thread Bolt*

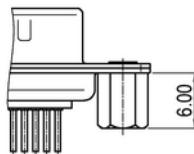

## Board Lock

**BL** Board Lock mit UNC 4-40 Gewinde  
*Board Lock with UNC 4-40 Thread*

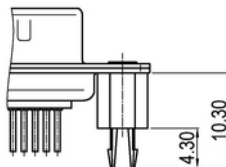

## Combi-Lock

**CL** Combi-Lock mit UNC 4-40 Gewinde  
*Combi Lock with UNC 4-40 Thread*

