

### Technische Daten / Technical Data

Isolierkörper	Thermoplast, nach UL94 V-0
Insulator	Thermoplastic, rated UL94 V-0
Kontaktmaterial	Kupferlegierung
Contact Material	Copper alloy
Kontaktoberfläche	Lt. Oberflächenoptionen, über Ni
Contact Surface	Acc. to plating options, over Ni
Durchgangswiderstand	< 25mΩ
Contact Resistance	< 25mΩ
Isolationswiderstand	> 1000MΩ
Insulation Resistance	> 1000MΩ
Spannungsfestigkeit	500V <sub>AC</sub>
Test Voltage	500V <sub>AC</sub>
Temperaturbereich	-55°C ... +125°C
Temperature Range	-55°C ... +125°C
Verarbeitung	Reflow-Lötverfahren
Processing	Reflow soldering

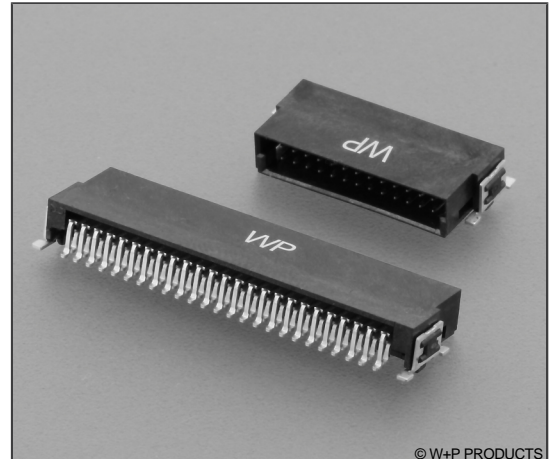

© W+P PRODUCTS

nnectors:  
J12 9013

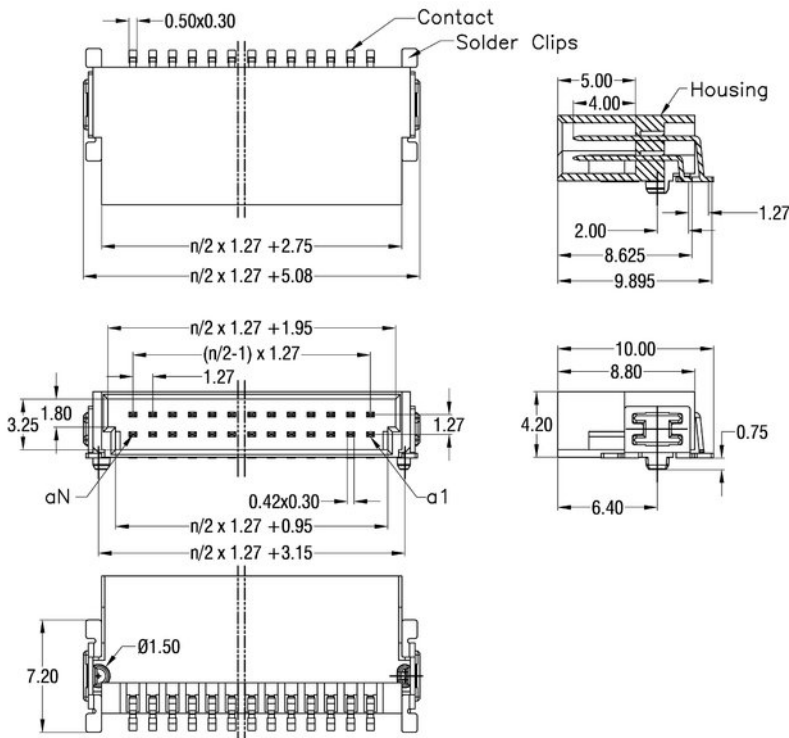

### Current Rating :

No of pos	Ambient Temp		
	20°C	70°C	100°C
12	1.6A	1.1A	0.7A
26	1.3A	0.9A	0.6A
50	1.1A	0.8A	0.5A
68	1.0A	0.8A	0.5A
80	1.0A	0.8A	0.5A

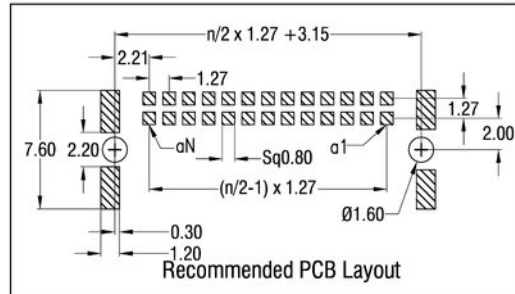

### Series

**9014**

### Contacts\*

**50**

12 26 50 68 80  
Weitere Polzahlen auf Anfrage  
More contact options on request

### Plating\*

**80**

60 Sel. Au flash / Sn  
80 Sel. Au 30µ" / Sn  
908 Sel. 8u"PdNi / 2u"Au  
928 Sel. 28u"PdNi / 2u"Au

### Packaging\*

**ST**

ST  
TR

Übersicht über Bauhöhen in den technischen Informationen  
Mating Height Chart under technical information

\* Dies ist ein **Bestellbeispiel** - bitte durch Ihre Spezifikationen ersetzen.  
\* This is an **order example** - please replace by your specifications.

### Lieferformen / Packaging Options:

**ST** In Stangen ohne Pick&Place-Pads / In tubes w/o Pick&Place-Pads  
**TR** Tape & Reel ohne PP-Pads / Tape & Reel w/o PP-Pads

# 9012 9013 9014 9015

## Übersicht über die erreichbaren Bauhöhen Chart of Attainable Mating Heights

### 9013 + 9015

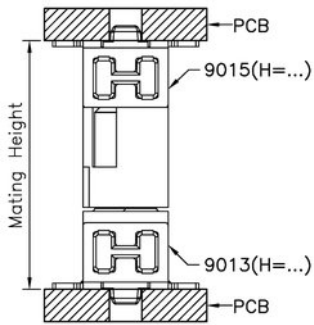

Mating Height		9015		
		H=6.75mm	H=8.25mm	H=9.85mm
9013	H=6.25mm	8.0 - 9.5	9.5 - 11.0	11. - 12.6
	H=9.05mm	10.8 - 12.3	12.3 - 13.8	13.9 - 15.4
	H=13.65mm	15.4 - 16.9	16.9 - 18.4	18.5 - 20.0

### 9012 + 9015

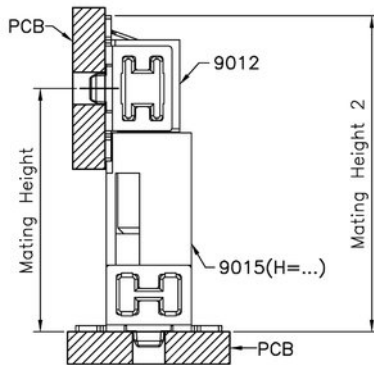

Mating Heights		9015		
		H=6.75mm	H=8.25mm	H=9.85mm
9012	8.95 - 10.45	10.45 - 11.95	12.05 - 13.55	
	12.55 - 14.05	14.05 - 15.55	15.65 - 17.15	

### 9013 + 9014

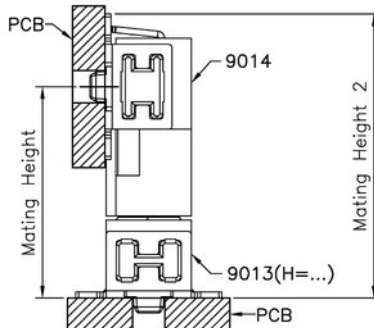

Mating Heights		9013		
		H=6.25mm	H=9.05mm	H=13.65mm
9014	7.65 - 9.15	10.45 - 11.95	15.05 - 16.55	
	11.25 - 12.75	14.05 - 15.55	18.65 - 20.15	

### 9012 + 9014

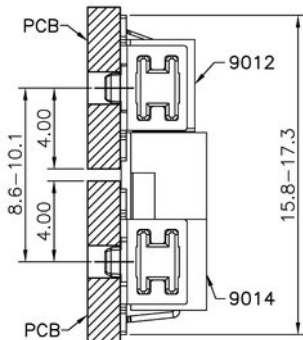

### Reflow-Lötempfehlung

*Reflow Soldering Recommendation*

Die Bauteile sollten gemäß folgendem Temperatur-Profil in Anlehnung an die IPC/JEDEC J-STD-020C für bleifreies Löten im Reflow-Verfahren verarbeitet werden (Maximalwerte).

Profileigenschaft	Kennwert
Temperatur Minimum $T_{Smin}$	150°C
Temperatur Maximum $T_{Smax}$	200°C
Dauer $T_{Smin} - T_{Smax}$	60-180s
Temperatur Lötbereich $T_L$	217°C
Verweildauer oberhalb $T_L$	60-180s
Ramp-Up Rate $T_{Smax} - T_P$	max. 3°C / s
Höchsttemperatur $T_P$	260°C ±5
Dauer Höchsttemperatur	20-40s
Ramp-Down Rate $T_{Pmax} - T_{Smin}$	6°C / s
Dauer 25°C - Höchsttemperatur $T_P$	Max. 8 min

*Items should be soldered according to IPC/JEDEC J-STD-020C temperature profile for leadfree reflow soldering (maximum values).*

Profile Feature	Key Values
Minimum Temperature $T_{Smin}$	150°C
Maximum Temperatur $T_{Smax}$	200°C
Duration $T_{Smin} - T_{Smax}$	60-180s
Soldering Range Temperature $T_L$	217°C
Duration above $T_L$	60-180s
Ramp-Up Rate $T_{Smax} - T_P$	max. 3°C / s
Peak Temperature $T_P$	260°C ±5
Duration Peak Temperature	20-40s
Ramp-Down Rate $T_{Pmax} - T_{Smin}$	6°C / s
Duration 25°C - Peak Temp. $T_P$	Max. 8min

