

USB 2.0 Steckverbinder Typ A zur Gehäusemontage IP67 / IP68 USB 2.0 Type A Panel Mount Connectors IP67 / IP68

Technische Daten / Technical Data

Isolierkörper <i>Insulator</i>	Thermoplast <i>Thermoplastic</i>
Kontaktmaterial <i>Contact Material</i>	Kupferlegierung <i>Copper alloy</i>
Kontaktoberfläche <i>Contact Surface</i>	Vergoldet 30µ" <i>Gold plated 30µ"</i>
Durchgangswiderstand <i>Contact Resistance</i>	< 30mΩ <i>< 30mΩ</i>
Isolationswiderstand <i>Insulation Resistance</i>	> 1000MΩ <i>> 1000MΩ</i>
Spannungsfestigkeit <i>Test Voltage</i>	500V _{AC} @ 1min <i>500V_{AC} @ 1min</i>
Nennstrom <i>Current Rating</i>	1,5A <i>1.5A</i>
Temperaturbereich <i>Temperature Range</i>	-20°C ... +80°C <i>-20°C ... +80°C</i>
Verarbeitung <i>Processing</i>	Wellenlötverfahren <i>Wave soldering</i>



© W+P PRODUCTS

Passende Produkte:
Compatible Products:
WA826 W900

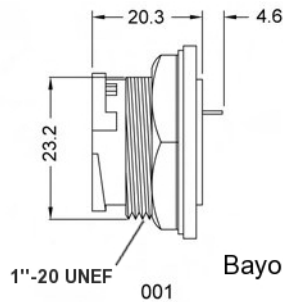
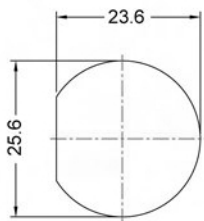

Bayonet Type

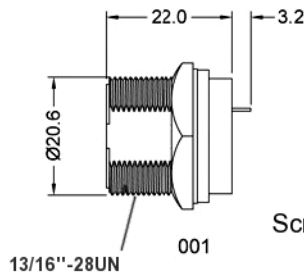
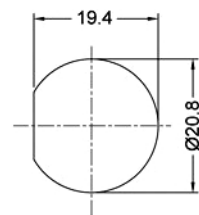
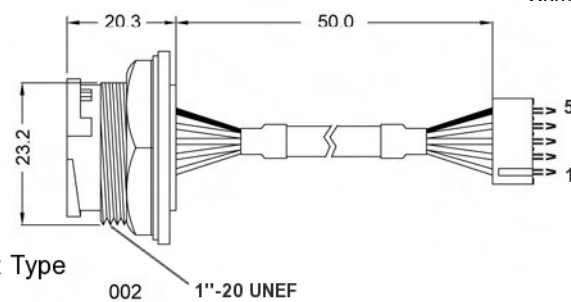

Screw Type

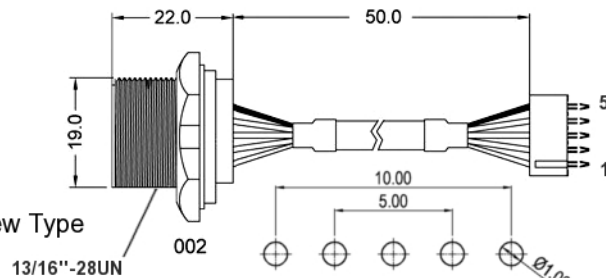

Flying Lead PCB Layout

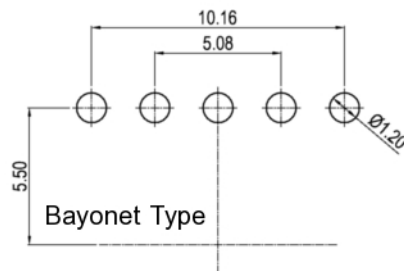
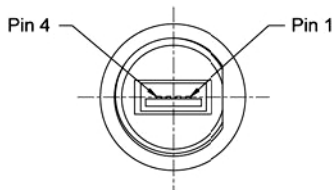

Bayonet Type

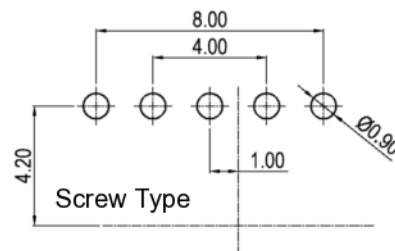

Screw Type

Series	USB Type	Lock / IP Class*	Terminals*	Length of Leads*
W824	1 1 USB A Female	18 18 Screw 13/16" (IP68) 27 Bayonet (IP67)	1 0 Litzen unbestückt ohne Schrumpfschlauch <i>Cuttet wires w/o heat shrink tube</i> 1 Lötstifte <i>PCB Pins</i> 2 Litzen mit Stiftheiste RM 2,5mm <i>Flying leads, 2,5mm pitch terminal</i>	005 000 Ohne Kabel <i>No Leads</i> 005 Länge in cm <i>Length in cm</i>

* Dies ist ein **Bestellbeispiel** -
bitte durch Ihre Spezifikationen ersetzen.
* This is an **order example** -
please replace by your specifications.