

HOW TO ORDER

S P C — [] [] — [] [] — [] [] — [] [] [] []

Function Code		Apparent shaped/Terminal type		Cap Color		LED Colors	
MS	Momentary, SPDT	SP	Square/Straight PC	T1	Transparency Red	00	Without LED
MD	Momentary, DPDT	RP	Rectangular/ Straight PC	T2	Transparency Yellow	Single Colors	
AS	Alternate, SPDT	SS	Square/Soldering type	T3	Transparency Green	01	Red
AD	Alternate, DPDT	RS	Rectangular/Soldering type	T5	Transparency Black	S2S	Super Yellow
I	Indicator			T7	Transparency Blue	P3S	Pure Green
				T	Transparency	7S	Blue
					The diffuser inside the cap are all in white.	Bi-colors LED	
						1S2	Red/Super Yellow
						1P3	Red/Pure Green
						17	Red/Blue
						S2P3	Super Yellow/Pure Green
						S27	Super Yellow/Blue
						P37	Pure Green/Blue
						Tri-colors LED	
						RGB	RGB Full color

EXAMPLE : SPC-MS-SS-T-1P3
 SPC Pushbutton switch -Momentary-Square/Soldering type terminal-Transparency Clear cap-Red/Pure Green LED illuminated.



- General Specifications**
- Circuit : SPDT or DPDT
 - Current Rating : 5A.
 - Voltage Rating : 125/250 V AC
 - Contact Resistance : 50 milli-Ohm Max(initial)
 - Insulation Resistance : 200 Meg-Ohm Min
 - Operating Force : Single pole: 190gf±50gf
 - Double pole: 250gf±50gf for Square
 - 300gf±50gf for Rectangular
- Mechanical Life** : 2.3mm±0.5mm
- Mechanical Life : 1,000,000 cycles min. for Momentary.
 - 200,000 cycles min. for Alternate.
 - Electrical Life : 10,000 cycles min.
 - 100,000 cycles min. with resistive load of 3A @ 125VAC
- Solder Specifications**
- : Manual solder, 360 deg. for 4 seconds
 - Wave solder for Through hole 260deg for 3 seconds
- Operating Temperature** : -25deg~+50deg
- Function** : Momentary or Alternate
- LED Rating** : See the table at below
- Material**
- Cap : Polycarbonate(PC)
 - Housing : Polyamide (PA)
 - Snap-in Frame : Stainless steel
 - Switch/LED Terminal : Phosphor bronze (PBS) with gold plating
 - Movable Contacts : Silver alloy
 - Spring : Piano wire
 - Base : Polyamide(PA)
 - LED : Surface type LED

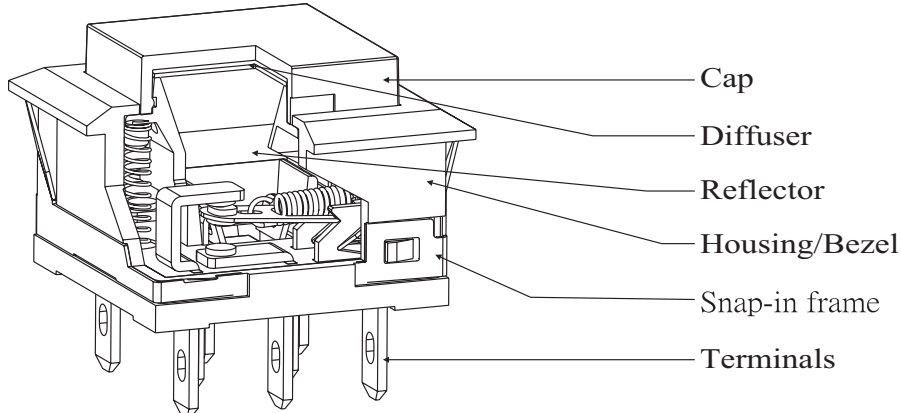

SPC Pushbutton Switches

CONTACT CONFIGURATION & LED SCHEMATICS



Single color LED



Dual Colors LED

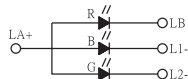

Full (RGB) Colors LED



SPDT

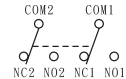

DPDT

Notes: LED circuit is isolated and requires external power source.

PANEL CUTTING

Square.Solder Lug

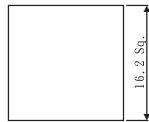
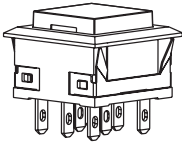

Panel Thickness: 1.0~3.2mm

Rectangular.Solder Lug

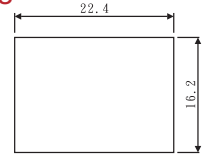
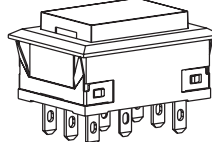

Panel Thickness: 1.0~3.2mm

TERMINALS

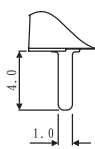

Straight PC type

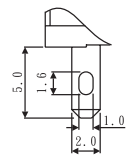

Soldering type

Switch pins, Thickness=0.5mm

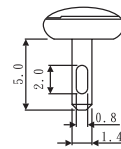

Soldering type
Dual & RGB LED pins

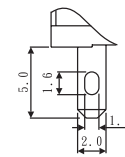

Soldering type
Single & Dual LED pins

LED pins, Thickness=0.3mm

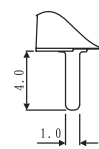

Straight PC type

MODEL OPTIONS

Square . For PCB

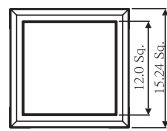
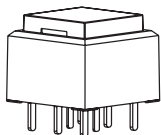

Single Color LED

Single & Double Pole : Single pole do not have terminals Com.2, NO.2 and NC.2

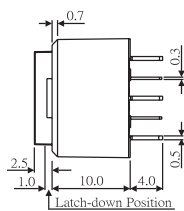

Latch-down Position

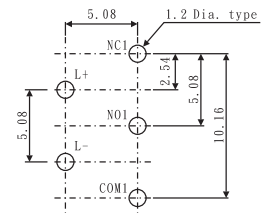
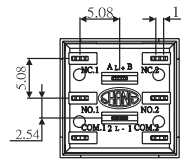

Single color LED

Square . For PCB

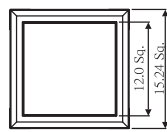
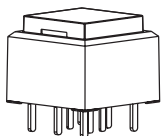

Dual Color LED

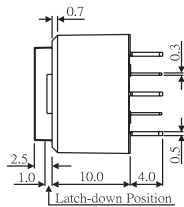

Latch-down Position

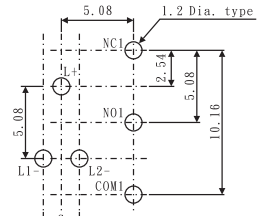
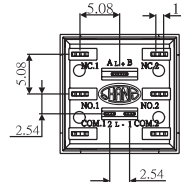

Dual colors LED

Square . For PCB

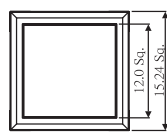
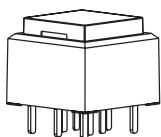

Full Color(RGB) LED

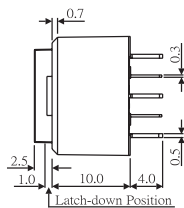

Latch-down Position

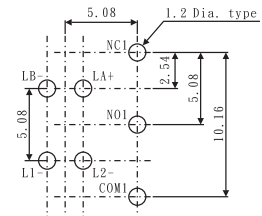
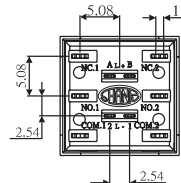

Full colors (RGB) LED

Rectangular . For PCB

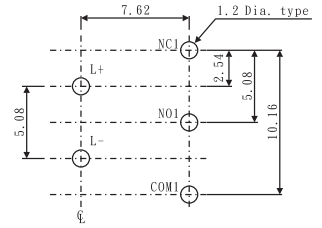
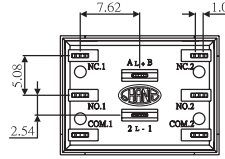
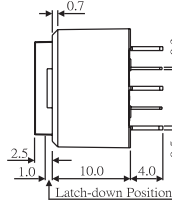
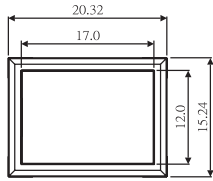
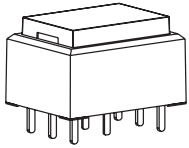

Single Color LED

Rectangular . For PCB

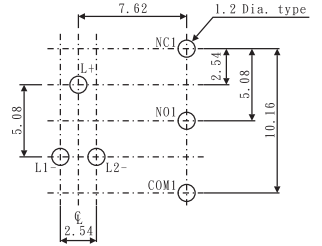
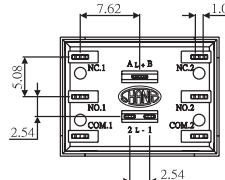
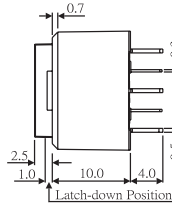
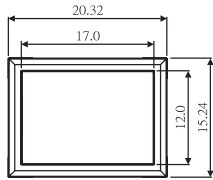
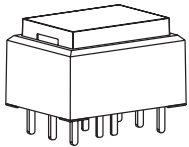

Dual Color LED

Rectangular . For PCB

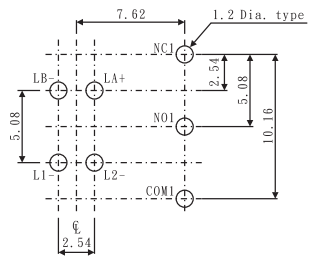
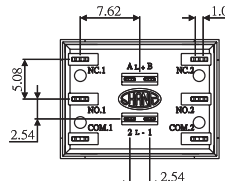
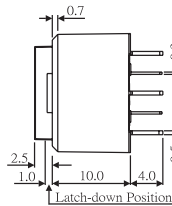
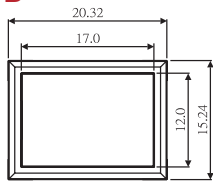
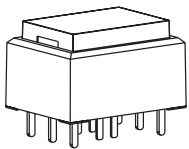

Full Color(RGB) LED

Square . Solder Lug

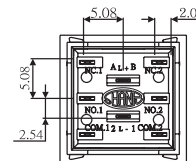
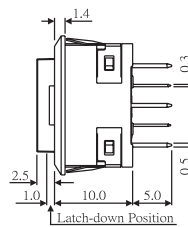
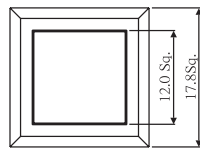
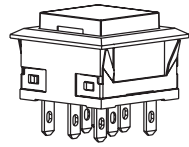

Single Color LED

Square . Solder Lug

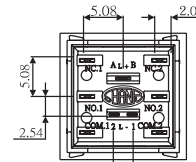
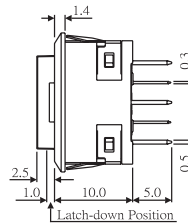
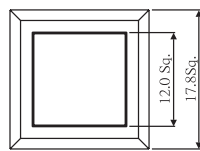
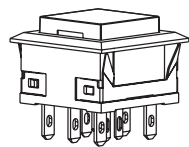

Dual Color LED

Square . Solder Lug

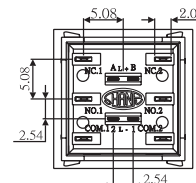
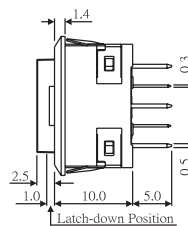
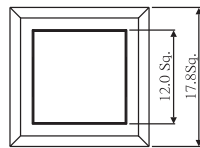
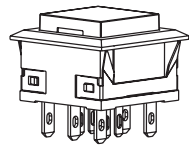

Full Color(RGB) LED

Rectangular . Solder Lug

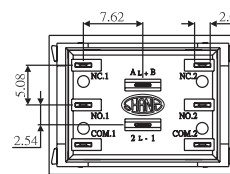
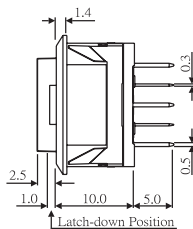
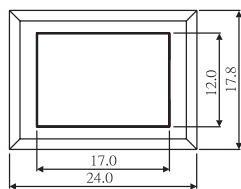
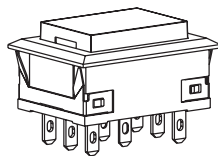

Single Color LED

Rectangular . Solder Lug

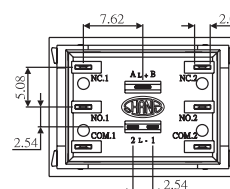
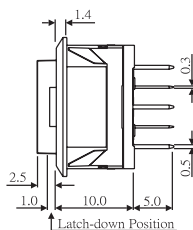
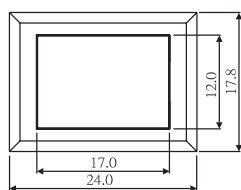
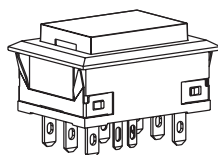

Dual Color LED

Rectangular . Solder Lug

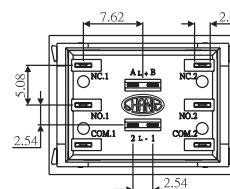
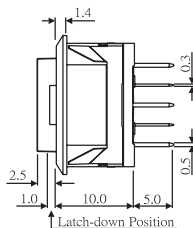
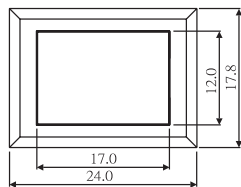
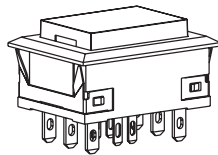

Full Color(RGB) LED

LED CHARACTERISTICS

The electrical specifications show are determined at a basic temperature of 25 . If the source voltage exceeds the rated voltage of LED, a ballast resistor must be connected in series with the LED.



Attention: LED are electrostatic sensitive devices

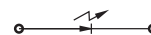

Single color	Forward Voltage $V_f(V)$ at 20mA	Forward Current $I_f(mA)$	Reverse Voltage $V_R(V)$	Reverse Current $I_R(uA)$ at $V_R=5V$
bi-Red Super Yellow Pure Green Blue	1.8~2.6 2.0~2.5 2.8~3.7 3.1~3.6	Typical 20mA 30 mA max.	5V	10uA
Bicolor LED				
Red+Yellow	Red 1.7~2.5 Yellow 1.7~2.5			
Red+Pure Green	Red 1.7~2.5 Pure Green 2.8~3.7			
Red+Blue	Red 1.7~2.5 Blue 2.8~3.7			
Yellow+Pure Green	Yellow 1.7~2.5 Pure Green 2.8~3.7			
Yellow+Blue	Yellow 1.7~2.5 Blue 2.8~3.7			
Full color (RGB) LED				
RGB	Red 3.2~3.6 Green 3.5~4.0 Blue 3.5~4.0			

- Notes:**
- 1.LED circuit is isolated and requires external power source.
 - 2.LED an integral part of the switch.
 - 3.Emitting color: $\pm 20\%$
 - 4.Forward Voltage: $\pm 0.1V$
 - 5..Luminous intensity / Luminous Flux: $\pm 20\%$