

Crimp-Verbinder RM 3,96mm, gerade, Einlöt-Kontakte Crimp Connectors, 3.96mm Pitch, Straight, Solder-In Terminals

Technische Daten / Technical Data

Isolierkörper <i>Insulator</i>	Thermoplast, nach UL94 V-0, halogenfrei <i>Thermoplastic, rated UL94 V-0, halogen-free</i>
Farbe <i>Colour</i>	Weiß <i>White</i>
Kontaktmaterial <i>Contact Material</i>	Kupferlegierung <i>Copper alloy</i>
Aderquerschnitt <i>Applicable wire Gauge</i>	AWG 22 ~ 16 <i>AWG 22 ~ 16</i>
Durchgangswiderstand <i>Contact Resistance</i>	< 20 mΩ <i>< 20 mΩ</i>
Isolationswiderstand <i>Insulation Resistance</i>	> 1000 MΩ <i>> 1000 MΩ</i>
Spannungsfestigkeit <i>Test Voltage</i>	800 V AC <i>800 V AC</i>
Nennspannung <i>Voltage Rating</i>	250 V AC/DC <i>250 V AC/DC</i>
Nennstrom <i>Current Rating</i>	7 A AC/DC <i>7 A AC/DC</i>
Temperaturbereich <i>Temperature Range</i>	-25 °C ... +85 °C <i>-25 °C ... +85 °C</i>
Verarbeitung <i>Processing</i>	Wellenlötverfahren <i>Wave soldering</i>

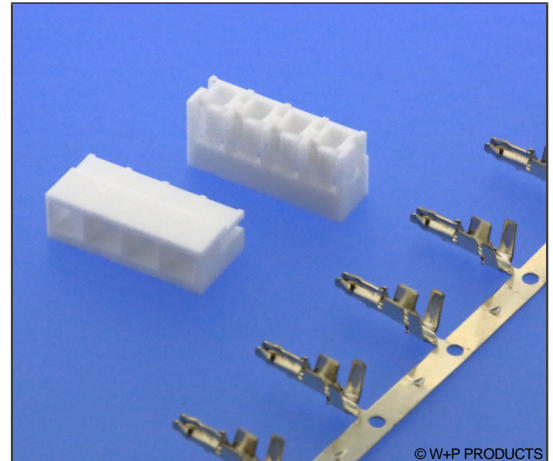

© W+P PRODUCTS

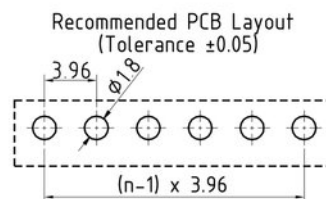
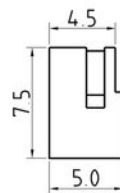
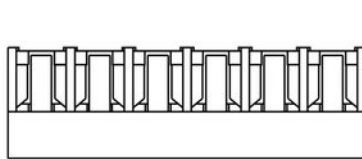
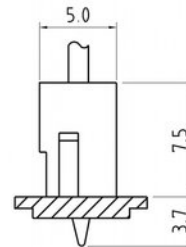
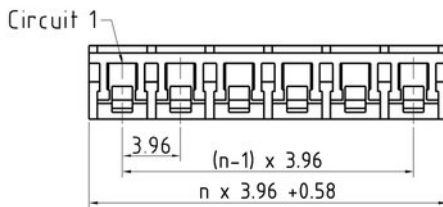

Series

593

Contacts*

05

02-15

Type

1

1 Gehäuse für Crimp-Kontakte
Housing for crimp terminals

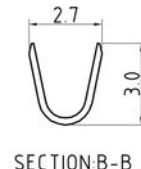
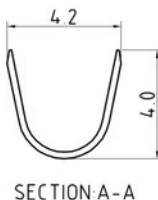
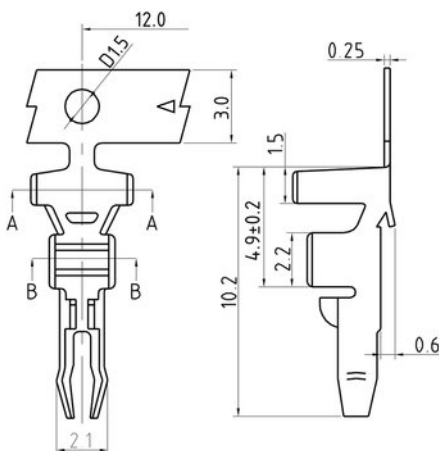

Series

593

Contacts

01

Type

2

2 Crimp-Leiterplatten-Kontakte
Crimp terminals

Plating

50

50 Sn

* Dies ist ein **Bestellbeispiel** -
bitte durch Ihre Spezifikationen ersetzen.
* This is an **order example** -
please replace by your specifications.

Empfehlungen für das Wellenlötverfahren

Recommendations for Wave Soldering

Die Bauteile sollten bei einer Lötbadtemperatur von 260°C in max. 5 Sekunden verlötet werden.
Items should be soldered at a solder temperature of 260°C in 5 seconds max.

Empfohlenes Wellenlötprofil:
Recommended wave soldering profile:

